



Features:

- Chrome plated to BS EN 248
- 5 year guarantee
- Lever handles
- Hose length 1750mm
- Can be used with standpipes on freestanding bath
- Compatible with low pressure water systems, optimised for UK market
- Quarter turn ceramic discs - for smooth operation and added durability
- Available in a selection of finishes

Product Certifications:



Additional Information:

Other Products in the Glastonbury range include:

- Basin Taps
- Basin Mixer
- Bath Filler
- Bath Taps
- Bidet Mixer

Available in Chrome, Vintage Gold with White Handle and Chrome with Midnight Blue Handle

Specification

Product Type:	Bathroom Tap
Main Construction Material:	Brass
Mount Type:	Deck Mounted
Handle Type:	Lever Handles
Connection Inlet:	G 3/4" BSP
Connection Outlet:	Open
Number of Tap Holes:	1
Valve/Cartridge Type:	Quarter Turn Ceramic Disc
Plumbing System Requirements:	All - Ideally Balanced
Working Pressure Range:	Min 0.2 Bar, Max 5.0 Bar
Maximum Hot Water Temperature: °C	65
Maximum Static Pressure: (bar)	10
Flow Type:	Single Flow
Isolation Included:	No

Dimensions (measurements in mm)

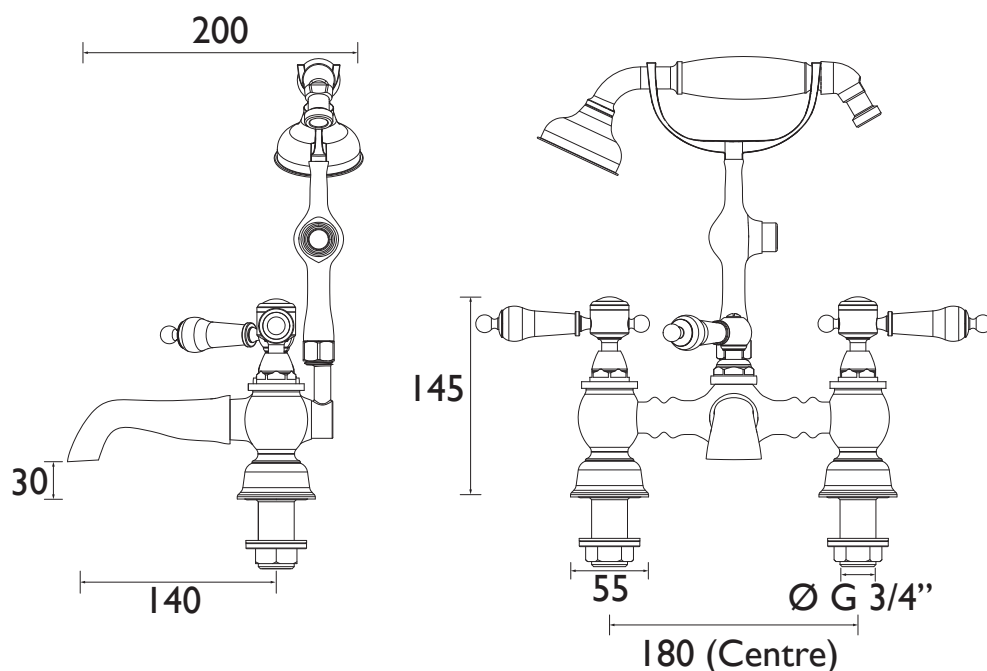

Flow Rates (l/min)

System Pressure (bar)	0.2	0.5	1	2	3	5
TGRC02	3.62	5.72	8.08	11.43	14	18.1