

Customer/technical services

For any technical or installation queries please contact Vado on 01934 745163.

Guarantee

This product is guaranteed against manufacturing defects from the date of purchase until the expiry of the relevant guarantee period shown below.

The guarantee is only valid if:-

1. The product has been installed, used and maintained in accordance with Vado's instructions and subjected to normal use only.
2. The defect is not due to use of an unsuitable or inadequate water or power supply.
3. The defect is not due to accident, misuse, neglect or repair other than by Vado or Vado authorised agents or damage caused by foreign objects or substances.
4. We have received from you the completed Guarantee Registration Form. Vado accepts no responsibility for any forms lost in the post and returns by registered means is therefore recommended.

Under this guarantee (which is non-transferable) Vado will, at its option, repair or replace free of charge any product (or replacement part) found to be defective. The guarantee does not extend to any consequential loss or damage. After repair or replacement the relevant guarantee period will be calculated from the original date of purchase.

The relevant guarantee periods are:-

1. Twelve years on chrome finish products.
2. Six years on Vado Identity products.
3. Three years on all other products with the exception of Stuart Turner Pumps which carry a 2 year Guarantee on Monsoon Range and 1 Year Guarantee on Showermate Range.

All claims under the guarantee must be submitted in writing to the person who supplied the product to you and must be received no later than the last day of the relevant guarantee period. All claims must be accompanied by proof of purchase (sales receipt or delivery note).

Vado operates a policy of continuous product development and therefore reserves the right to change the product, packaging and documentation specifications without notice.

This guarantee is in addition to and does not affect your statutory rights as a consumer.

Vado

Wedmore Road, Cheddar, Somerset, England BS27 3EB
tel 01934 744466. fax 01934 744345
technical@vado-uk.com
www.vado-uk.com



Installation & maintenance instructions

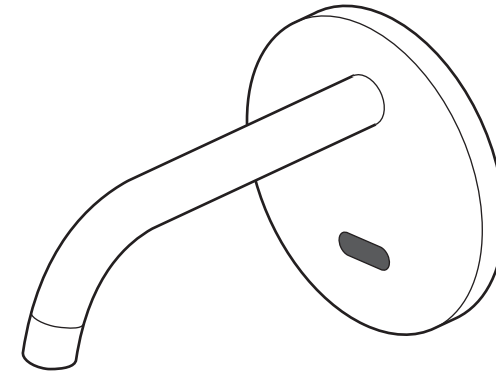

ZOO

Mono basin filler with infrared sensor

GUARANTEE REGISTRATION

NAME				
ADDRESS				
	POSTCODE			
RETAILER				
ADDRESS				
	POSTCODE			
PURCHASE DATE	ARTICLE NUMBER	(SEE BOX)		
PRODUCT DESCRIPTION				
WHO INSTALLED THE PRODUCT?	RETAILER	PLUMBER	BUILDER	SELF
FOR VADO USE				

Please leave these instructions with the customer

Important - please read

Please read these instructions carefully before starting installation and keep for future reference.

Remove all packaging and check the product for missing parts or damage before starting installation.

Any alterations made to this product and fittings may infringe water and electrical regulations and will invalidate the guarantee.

Please note if installing in an enclosed environment, access should be left for servicing and maintenance. No costs relating to inadequate access can be accepted.

We strongly recommend that you use a qualified and registered plumber and electrician.

Plumbing Connections

The installation must comply with all Local/National Water Supply Authority Regulations/Byelaws and Building and Plumbing (UK:BS6700) Regulations.

Electrical Connections

All electrical connections should be carried out by a qualified electrician.

The installation must comply with current NICEIC regulations and to the requirements of BS7671 (Requirements for electrical installations).

Always switch off the power at the main consumer unit and isolate the electrical supply before making any electrical connections. This appliance is to be fitted with the relevant RCD protection.

All Vado electronic taps are IPX6 rated and are suitable for installation in zone 2 and beyond. The diagram below illustrates this zonal concept and must be followed to ensure safe installation of electrical bathroom products.

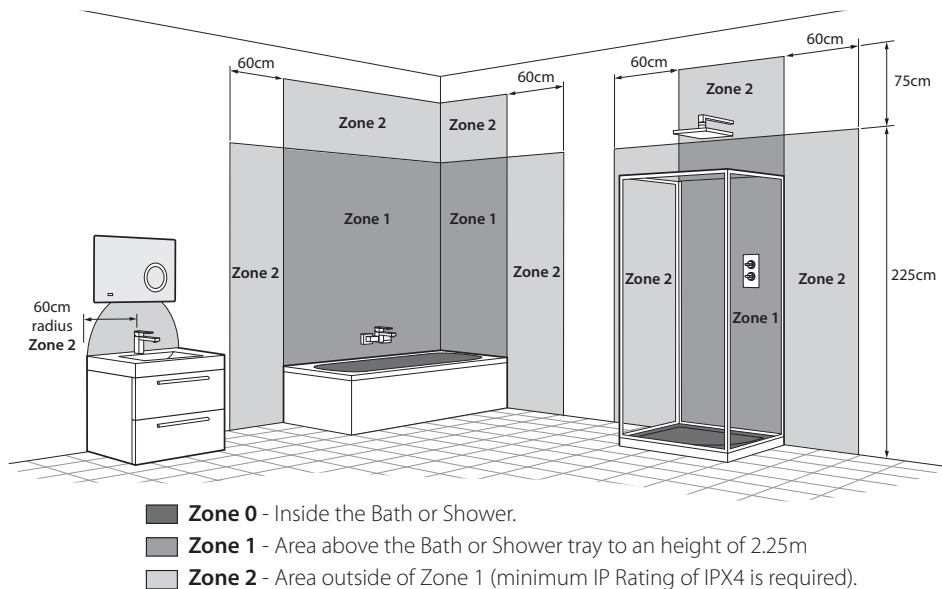

Installers/users notes

Declaration of Conformity



Declaration of Conformity

The infrared taps (electronic taps) listed below, comply with the essential requirements of the following EEC Directives;

2006/95/EC – The Low Voltage Directive

2004/108/EC – The Electromagnetic Compatibility Directive

2011/65/EU - Restriction of Hazardous Substances in Electrical and Electronic Equipment

And is in conformity to the applicable requirements to the following standards;

EN 55014-1:2006+A1:2009+A2:2011 BS EN 55014-1:2006+A2:2011. Electromagnetic compatibility. Requirements for household appliances, electric tools and similar apparatus. Emission

EN 55014-2:1997+A1:2001+A2:2008. Electromagnetic compatibility. Requirements for household appliances, electric tools and similar apparatus. Immunity. Product family standard.

EN 61000-3-2:2014. Electromagnetic compatibility (EMC). Limits. Limits for harmonic current emissions

EN 61000-3-3:2013. Electromagnetic compatibility (EMC). Limits. Limitation of voltage changes, voltage fluctuations and flicker in public low-voltage supply systems

BS EN 60335-1:2012+A11:2014. Household and similar electrical appliances. Safety. General requirements

BS EN 62233:2008. Measurement methods for electromagnetic fields of household appliances and similar apparatus with regard to human exposure

Model: IR-100/ASC-C/P, IR-100/LIF-C/P, IR-100/PRO-C/P, IR-100/SOH-C/P, IR-100/TE-C/P, IR-100/ZOO-C/P, IR-100/ZOOT-C/P, IR-109/NOT-C/P, IR-109/ZOO-C/P, IR-DSPOUT-C/P, IR-WSPOUT-C/P

Name: Adam Malein
Position: Approvals and Compliance Officer

Vado, Wedmore Road, Cheddar, Somerset, BS27 3EB

Dimensions

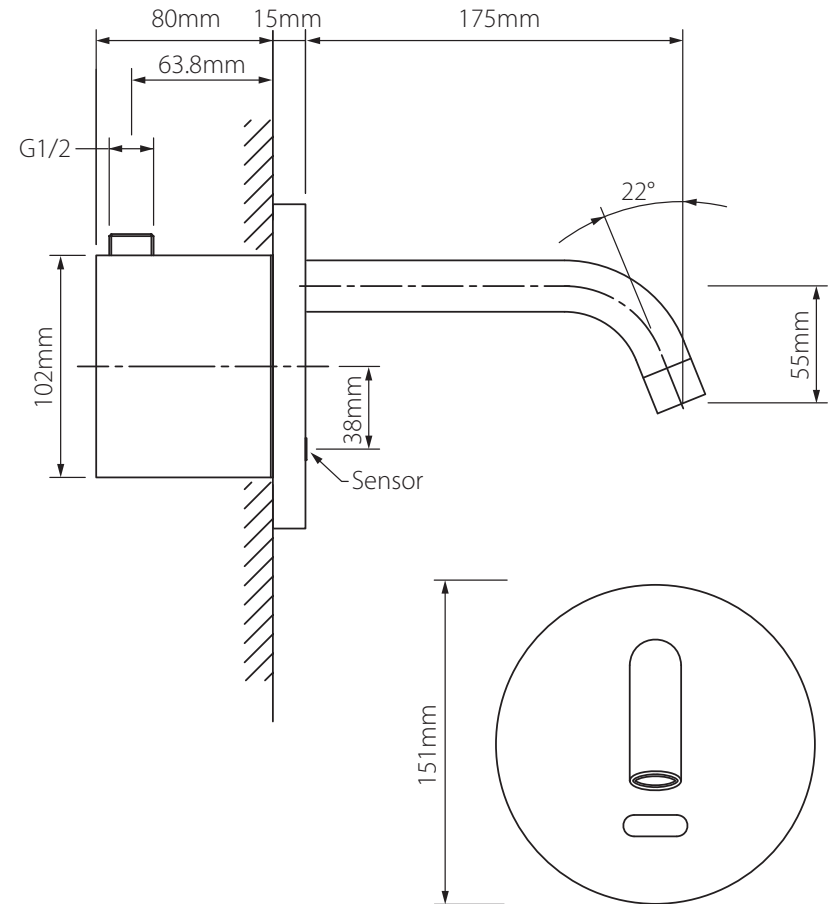

Operating Specifications

Operating Pressure:
Minimum operating pressure 0.5 bar
Maximum operating pressure 5 bar

Electrical connection

Mains electrical connection

Position the transformer in a suitable dry location and connect to ~230V 50 Hz AC mains supply via a suitable switched fused spur outside of the bathroom.

The mains cable can be connected to a 3 or 5 amp plug if required using the following connections.

Brown - (L) Live
Blue - (N) Neutral

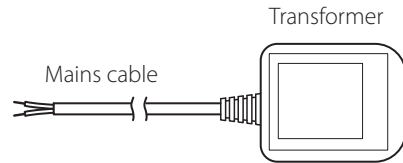

Note: If using a plug and socket the socket must not be installed within the bathroom.

Installation

For ease of installation the faceplate and battery can be disconnected from the unit at the connectors.

Faceplate and Spout

Push the spout through the hole in the faceplate and secure with the backing nut. Make sure that the hole is in the 12 o'clock position and the spout is pointing downwards (above).

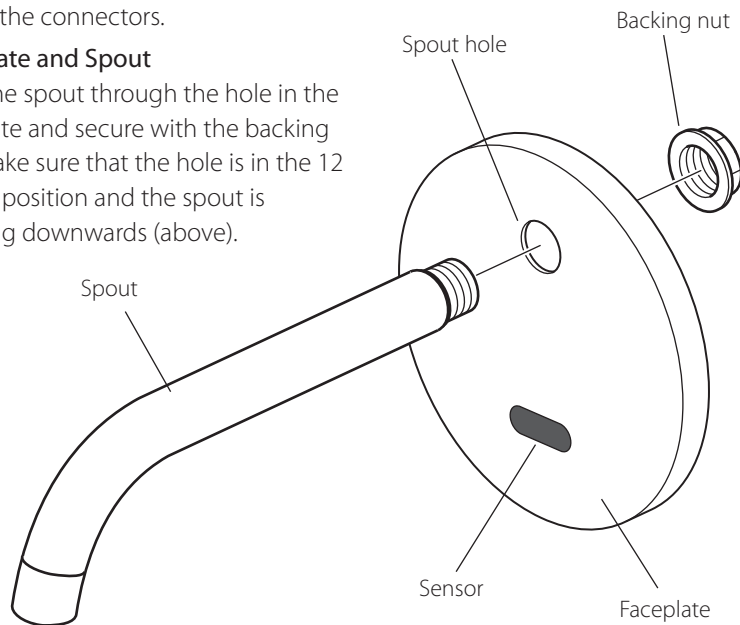

Disposal - please read

Waste electrical and electronic equipment (WEEE)

The wheeled bin symbol means the product is covered by the European Directive 2002/96/EC.

DO NOT dispose of this unit with normal household waste, take to a local authority recycling centre.



Troubleshooting

Description	Cause	Treatment
No water out	The batter is exhausted	Change the battery
	Water supply cut off	Check supply
	Dirt in the filter	Clean the filter
	Water pressure to low	Raise the pressure
Water will not turn off	Dirt on the sensor window	Clean the sensor
Too little water flow	Water supply is turned down	Adjust water supply
	The filter is too dirty	Clean the filter
	Water pressure is too low	Raise the pressure
Too much water flow	Water pressure is too high	Adjust pressure
Short cycles of battery	Incorrect batteries	Change to 4AA Alkaline batteries
The indicator light is not on	The light is broken	Change the light or circuit board
	The circuit board is wet or signal line is wet	Dry out
	The battery is exhausted	Change the battery
	Poor connection of battery	Check battery connections

Care of the mixer

Our products are finished to the highest standard and due care needs to be taken to ensure their looks are retained.

We recommend cleaning all products with a soft damp cloth ONLY and advise strongly against the use of ALL cleaning products i.e. powders and liquids.

If the above instructions are not followed this will invalidate your guarantee in the event of a problem occurring.

Installation

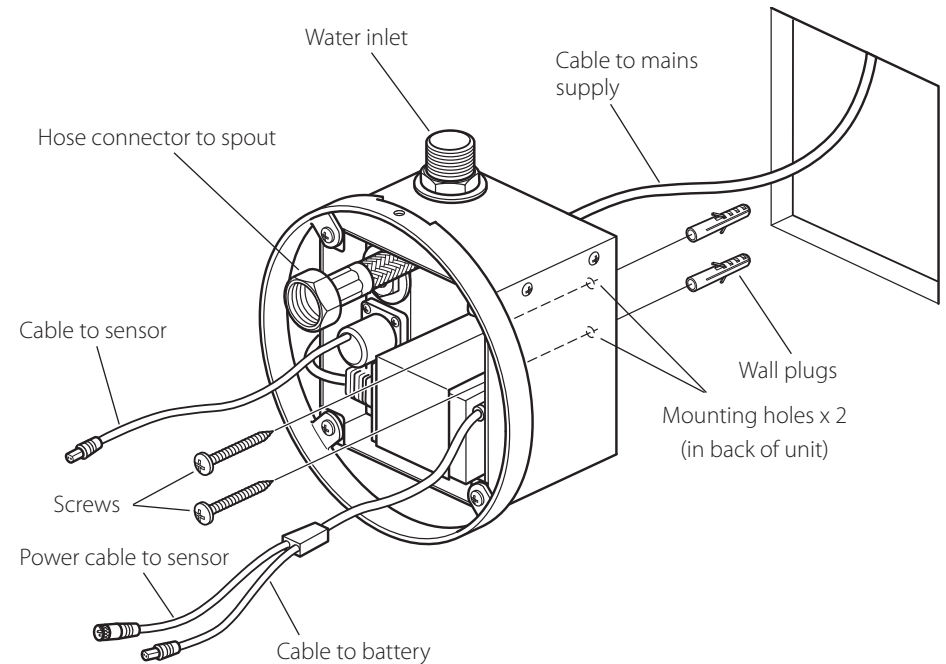

Note: Please do not install this product opposite or near any reflective surfaces as this may lead to false or permanent activation.

Before installing your new mixer, flush through the pipework to ensure removal of debris, turn off the water supply.

The valve must be set into the wall to depth of 80 mm.

If you are fitting the valve to a partition wall or a wall of particularly soft substrate you will need specialist fixings.

Select the position for the valve and offer the shower valve to the wall, mark the fixing points with a suitable pencil, there are 2 pre drilled holes in the back of the unit. Remove the valve from the wall, drill the holes to a suitable depth for the wall plugs and secure with suitable screws.

Installation

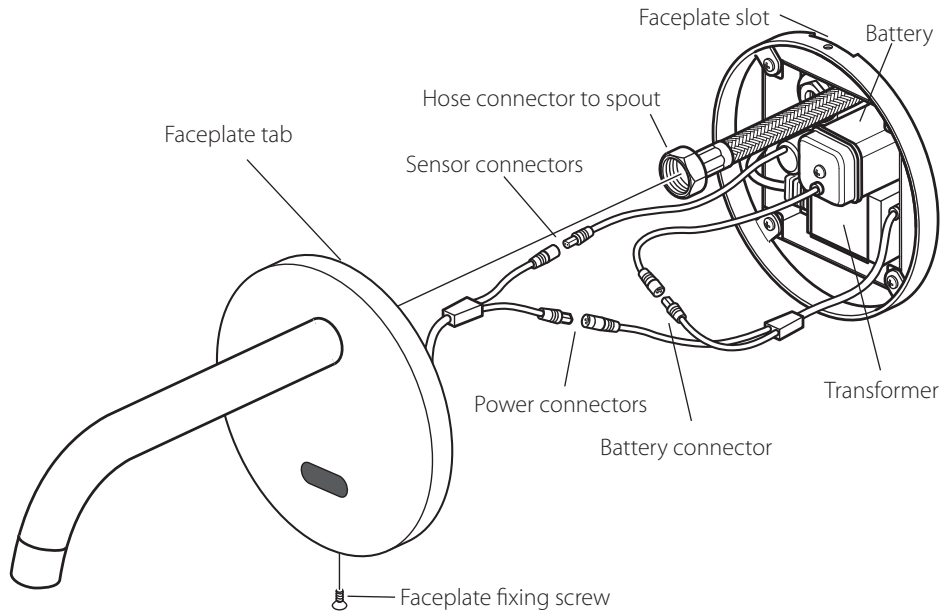

Connect the flexible hose coming from the unit onto the spout, making sure that the rubber washer is in place.

Sensor connections

Connect the plug coming from the valve unit to the socket coming from the sensor.

Power connections

Connect the socket coming from the transformer to the plug coming from the sensor.

Battery connections

Undo the screw on the top and remove the lid. Insert the 4 batteries into the base, according to the diagram in the bottom of the base. Replace the lid making sure that the 2 springs are orientated to match the negative ends of the 2 batteries (right).

Connect the plug coming from the transformer to the socket coming from the battery.

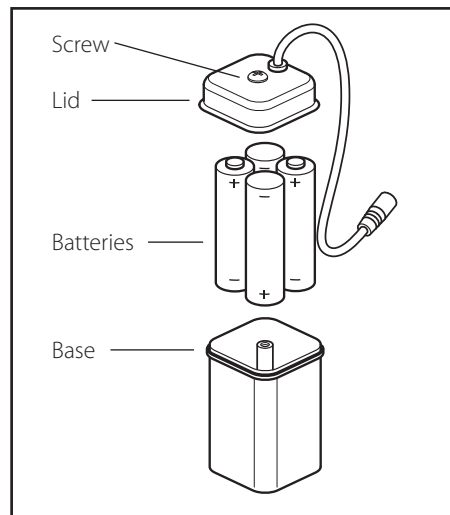

Installation

Slide the tab in the top of the faceplate over the slot on the faceplate fixing ring, and secure in position with the screw on the underside.

Please ensure that enough access is left for screw to be removed/inserted, during any routine maintenance.

Turn on the water.

Please read

This appliance can be used by children aged 8 years and above and persons with reduced physical, sensory or mental capabilities or lack of experience and knowledge if they have been given supervision or instruction concerning use of the appliance in a safe way and understand the hazards involved.

Children shall not play with the appliance.

Cleaning and user maintenance shall not be made by children without supervision.

Detachable hose-sets for the connection of appliances to the water mains shall comply with IEC 61770.