

IDEALSTREAM

Exposed pillar tap with tubular spout J181

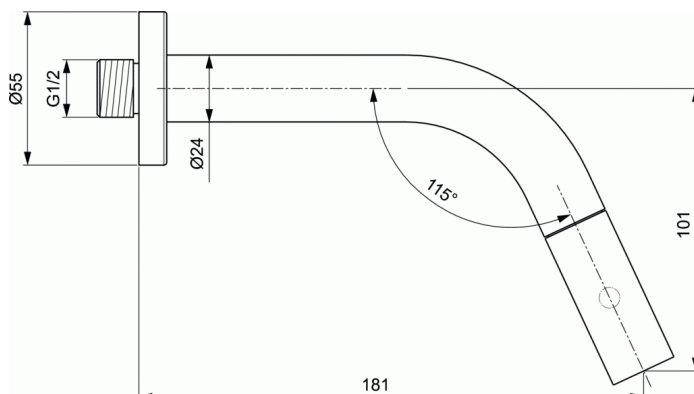

Exposed pillar tap with tubular spout J181

Pillar tap for cold or premixed water

Tubular spout J181

Volume control on the front end of the tubular spout

Hidden aerator Cache M21.5x1

G $\frac{1}{2}$ " Ceramic disc headpart opened and closed with a rotary handle

G $\frac{1}{2}$ " shank fixation

Flow rate at 3 bar 6 l/min

Comply with EN817

FINISHES*



* AA = Chrome

KEY FEATURES & BENEFITS

