

# BRISTAN

## Installation Instructions & User Guide

Please leave these instructions with the end user

Product Code: CARM WORD01 C (D1)

### Specifications

#### Working Pressures



Min: 0.2 bar Max: 5.0bar

Maximum Static Pressure: 10.0 bar

### Tools You'll Need

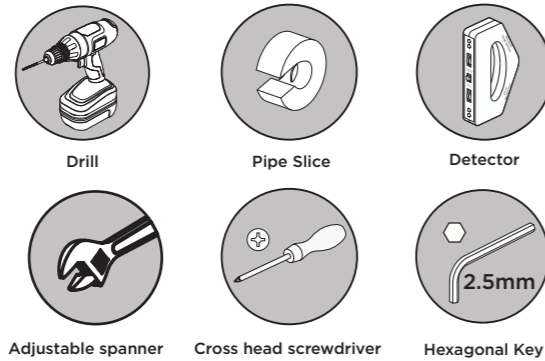

### Inlet Connections

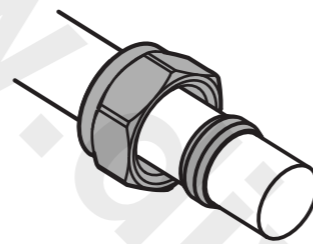

15mm Compression

### Prior to Installation

All products manufactured and supplied by Bristan are safe provided they are installed, used correctly and receive regular maintenance in accordance with these instructions.

Isolation valves **must** be fitted to the inlet water supplies to ensure ease of future maintenance.

This product **must** not be modified in any way as this will invalidate the guarantee.

Full access must be made available for future maintenance / servicing purposes. This product needs to be installed in accordance with, and meet the requirements of the Water Supply (Water Fittings) Regulations 1999 and Scottish Byelaws 2004.

Before starting any installation please consider the following: before drilling into walls, check that there are no hidden electrical wires, cables or water supply pipes. This can be checked with the aid of an electronic detector.

If power tools are used do not forget to:

- Wear eye protection
- Unplug equipment after use

Warning: It is essential that you thoroughly flush through the pipework in order to remove any remaining swarf, solder, etc before using this product. Failure to carry out this procedure could cause problems or damage.

If in doubt, contact a registered plumber or your Local Water Authority or the Secretary of the Institute of Plumbing, address as follows:-

The Institute of Plumbing,  
64 Station Lane,  
Hornchurch,  
Essex,  
RM12 6NB, Tel: 01708 472791

### Pack Contents

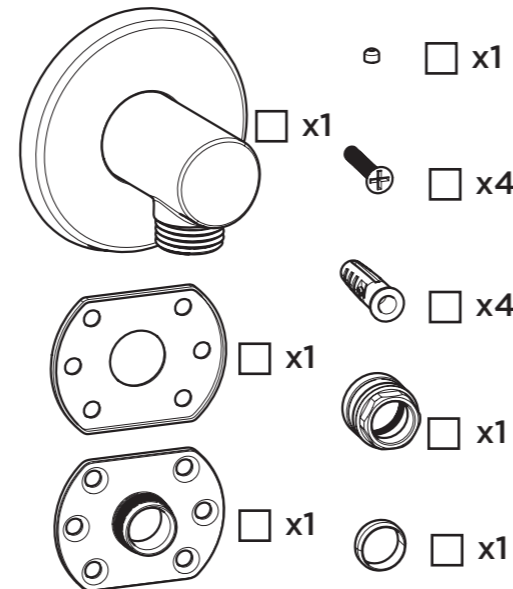

### Spare Parts

To replace any spare parts for your product why not scan the below QR Code and search for your product.



### Installation

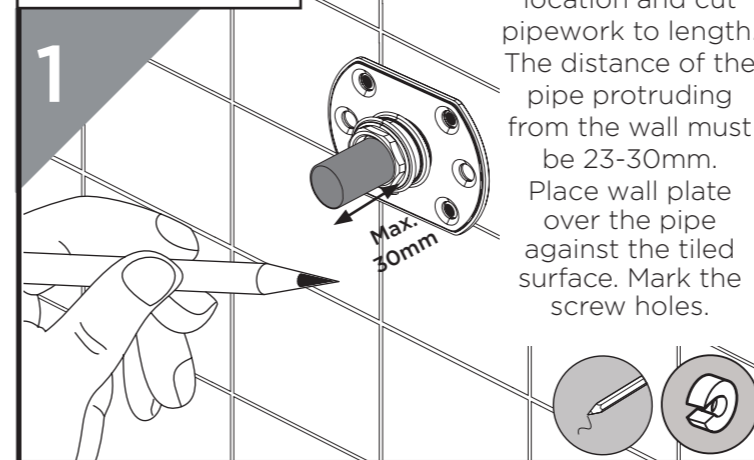

Fit plumbing to location and cut pipework to length. The distance of the pipe protruding from the wall must be 23-30mm. Place wall plate over the pipe against the tiled surface. Mark the screw holes.

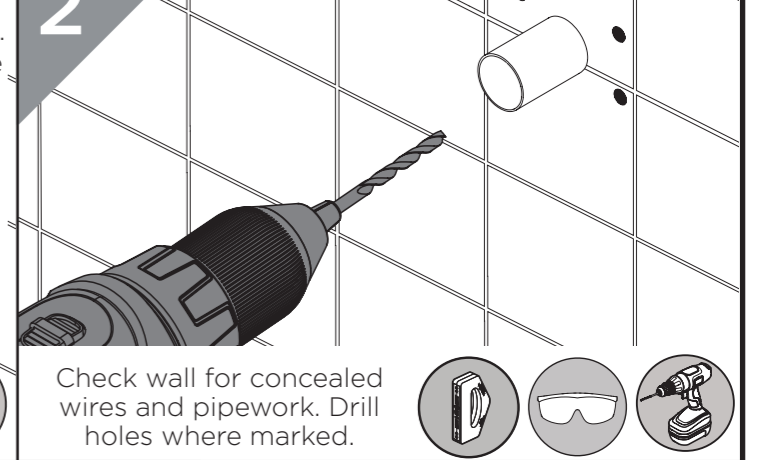

Check wall for concealed wires and pipework. Drill holes where marked.

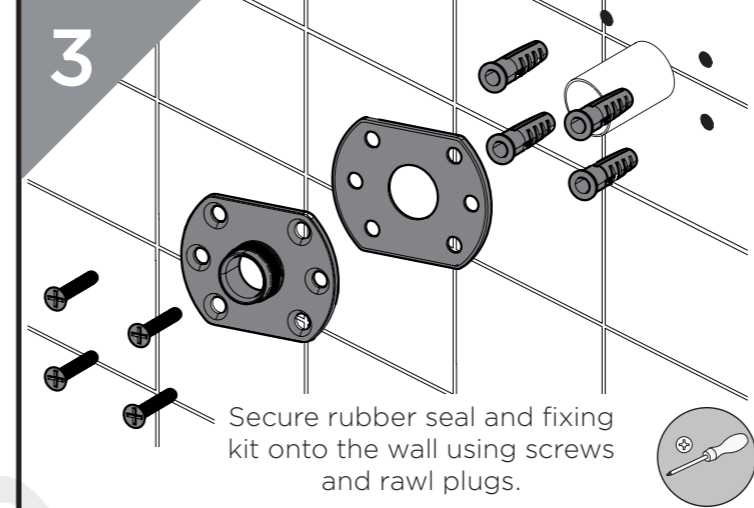

Secure rubber seal and fixing kit onto the wall using screws and rawl plugs.

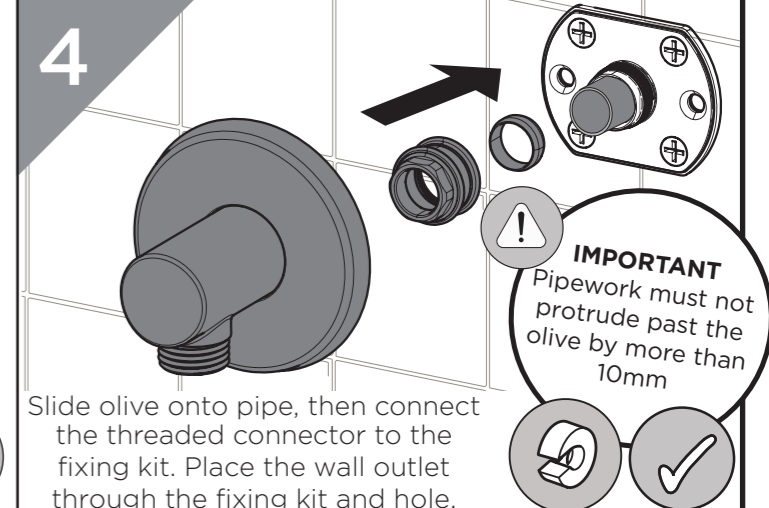

Slide olive onto pipe, then connect the threaded connector to the fixing kit. Place the wall outlet through the fixing kit and hole.

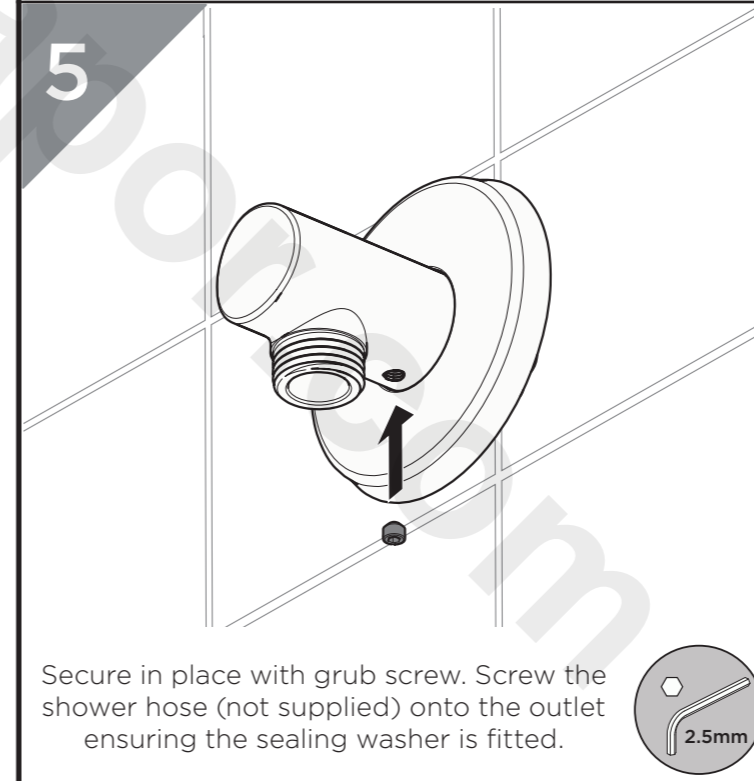

Secure in place with grub screw. Screw the shower hose (not supplied) onto the outlet ensuring the sealing washer is fitted.

### General Cleaning

Bristan products are made from premium materials, with hand polishing and electroplated finishes.

Your taps, shower and accessories should be regularly cleaned with warm water, a mild pH-neutral liquid soap, and polished with a soft cloth. Any residues from soap, toothpaste, shampoos and shower gels can cause blemishes if not rinsed off straight after use.

Household bleaches and cleaners contain harsh chemicals and may damage the surface finish. Avoid using abrasive cloths, scouring pads, scrub sponges, steel wool or anything similar.

Some surfaces such as nickel and pewter may be affected by the dye found in some cloths, so it is also important to avoid hanging cloths on spouts.

At Bristan, we want to make things as easy as possible for our customers. That's why we offer solid guarantees on all our products, effective from the date of purchase, to give you peace of mind.

To start your free guarantee simply scan the QR code and register your product. Alternatively visit [www.bristan.com/register](http://www.bristan.com/register) to register your product via a computer.

For full guarantee terms and conditions visit [www.bristan.com/guarantees](http://www.bristan.com/guarantees).



*We Know & We Care*