







36 607 811

- without rosette
- handle Ø 60mm
- head part with cut-to-length spindle and sleeve

Fits CYO

NOTE: The handle inserts must be ordered separately from the fittings!



	Brushed Platinum	36 607 811-06
	Chrome	36 607 811-00
	Dark Chrome	36 607 811-19
	Brushed Durabronze (23kt Gold)	36 607 811-28
	Platinum / Brushed Platinum	36 607 811-36
	Durabronze / Brushed Durabronze (23kt Gold)	36 607 811-38
	Brushed Dark Platinum	36 607 811-99

36 607 811

mm [inches]

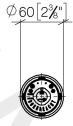

www.divapor.com

36 607 811

Parts for other
finishes can be found
here: [Chrome](#)

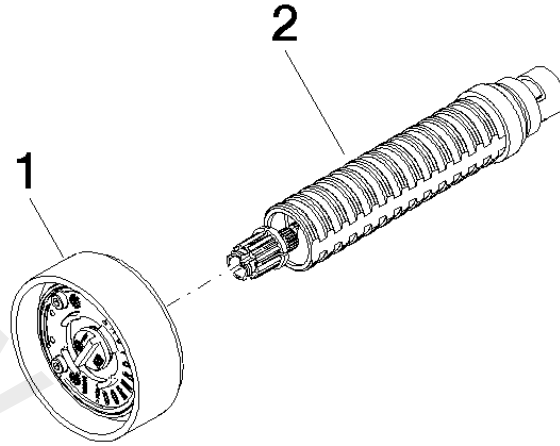

Spare parts list

No.	Item Number	Name	Quantity used	Delivery time
1	90 18 40 291 01-06	handle	1	10
2	90 90 03 172 01 90	top	1	2