

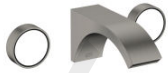







36 707 811



- 160 mm projection
- fixed spout
- rectangular, air-enriched flow
- hole diameter valve 37 mm
- hole diameter spout 37 mm
- handle Ø 60mm
- max. flow 4.5 l/min
- lead-free

NOTE: The handle inserts must be ordered separately from the fittings!

NOTE: The handle inserts must be ordered separately from the fittings!

	Brushed Dark Platinum	36 707 811-99
	Chrome	36 707 811-00
	Brushed Platinum	36 707 811-06
	Dark Chrome	36 707 811-19
	Brushed Durabronze (23kt Gold)	36 707 811-28
	Platinum / Brushed Platinum	36 707 811-36
	Durabronze / Brushed Durabronze (23kt Gold)	36 707 811-38

Required miscellaneous



Concealed wall-mounted mixer 35 700 970 90

Centred spout

- min. recess depth 93 mm
- max. recess depth 115 mm

36 707 811

mm [inches]

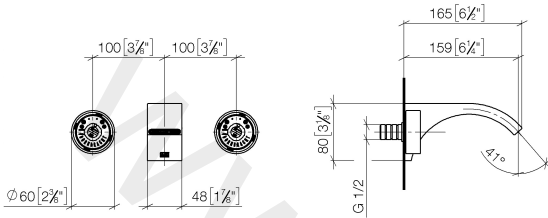

Flow rate chart

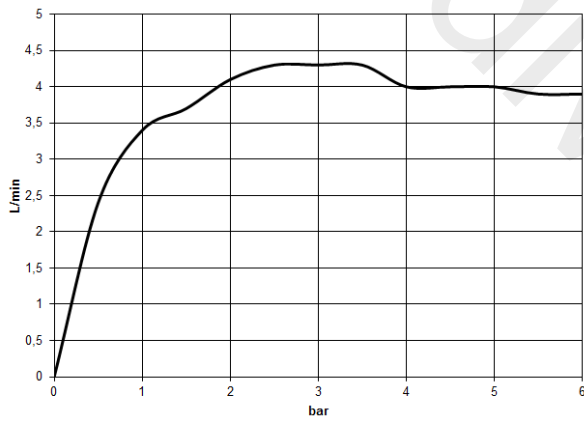

36 707 811

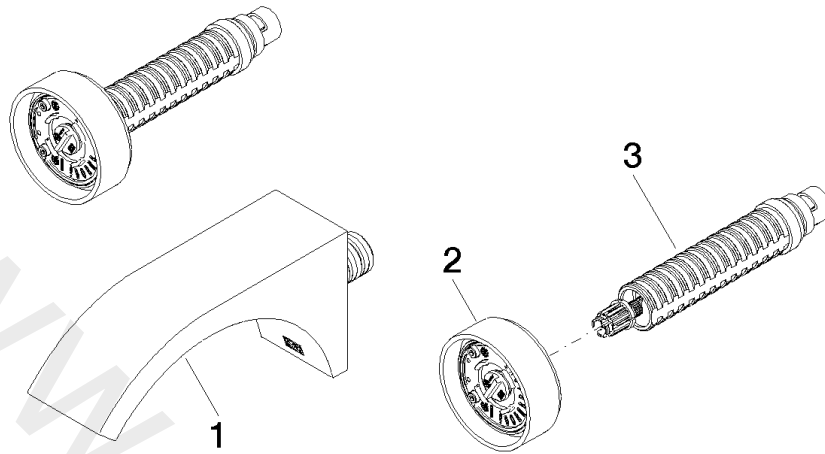

Spare parts list

No.	Item Number	Name	Quantity used	Delivery time
1	13 800 811-99	Wall-mounted basin spout without pop-up waste	1	30
2	90 18 40 290 00-99	handle	1	30
3	90 90 03 171 01 90	top	1	2