





Wall-mounted basin mixer without pop-up waste

CL.1

ST 010 201 0705



- 200 mm projection
- fixed spout
- rectangular spray pattern with 40 individual jets
- hole diameter valve 35 mm
- hole diameter spout 40 mm
- rosette 60 x 60 mm
- max. flow 4.5 l/min
- lead-free

	Brushed Dark Platinum	ST 010 201 0705-99
	Chrome	ST 010 201 0705-00
	Brushed Platinum	ST 010 201 0705-06
	Dark Chrome	ST 010 201 0705-19

Individual components of this set

You need the following components for this set

	1x	13 800 705-99		1x	36 607 706-99
	1x	36 607 707-99			

www.divapor.com





ST 010 201 0705



- 200 mm projection
- fixed spout
- rectangular spray pattern with 40 individual jets
- hole diameter 37 mm
- lead-free
- 1/2" connection
- plug-link mounting
- max. flow 4.5 l/min

Codes & standards

- NSF/ANSI 372

	Brushed Dark Platinum	13 800 705-99
	Chrome	13 800 705-00
	Brushed Platinum	13 800 705-06
	Dark Chrome	13 800 705-19

Recommended miscellaneous



Concealed wall elbow

35 085 970 90

- min. recess depth 90 mm
- max. recess depth 163 mm

ST 010 201 0705

mm [inches]

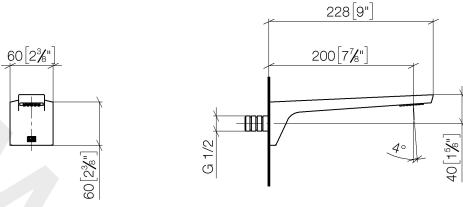

Flow rate chart



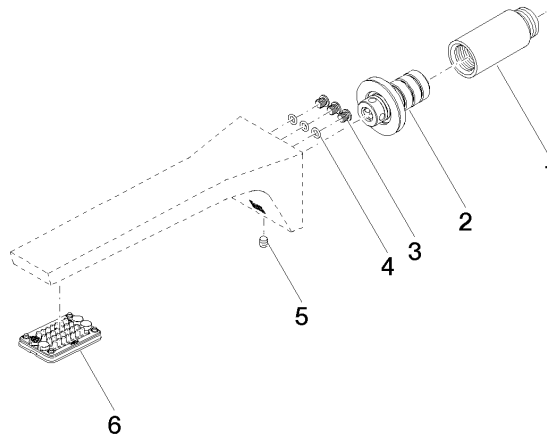

Spare parts list

No.	Item Number	Name	Quantity used	Delivery time
1	09 24 03 081 10 90	extension	1	2
2	90 24 03 108 01 90	nipple set	1	2
3	09 30 30 113 20 90	screw	3	2
4	09 14 10 001 90	seal	3	2
5	04 31 11 004 00 90	pin	1	2
6	90 11 02 297 00 90	aerator	1	2

ST 010 201 0705







- rosette 60 x 60 mm
- with cold marking
- head part with cut-to-length spindle and sleeve

Codes & standards

Fits CL.1

Fits CL.1

	Brushed Dark Platinum	36 607 706-99
	Chrome	36 607 706-00
	Brushed Platinum	36 607 706-06
	Dark Chrome	36 607 706-19

Required miscellaneous

Wall valve 1/2" 35 607 970 90



- min. recess depth 105 mm
- max. recess depth 150 mm

www.divapor.com

ST 010 201 0705

mm [inches]

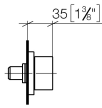
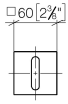

www.divapor.com

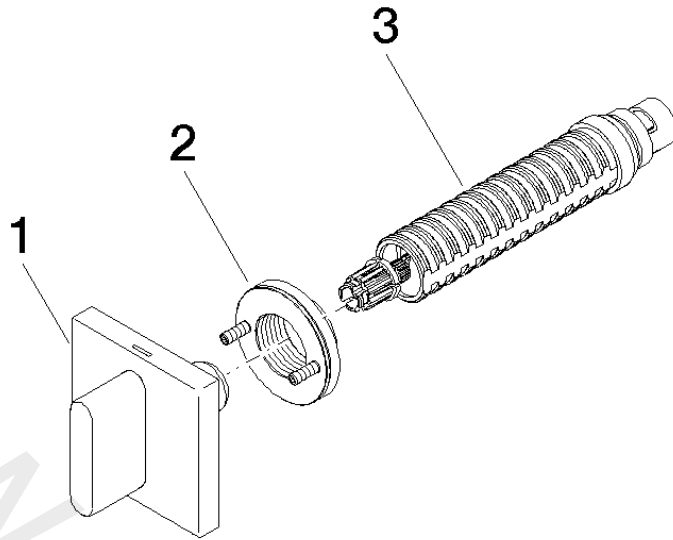

Spare parts list

No.	Item Number	Name	Quantity used	Delivery time
1	90 20 70 051 02-99	handle (cold)	1	30
2	90 21 02 108 00 90	disc	1	2
3	90 90 03 143 00 90	top	1	2

ST 010 201 0705







- rosette 60 x 60 mm
- with hot marking
- head part with cut-to-length spindle and sleeve

Codes & standards

Fits CL.1

Fits CL.1

	Brushed Dark Platinum	36 607 707-99
	Chrome	36 607 707-00
	Brushed Platinum	36 607 707-06
	Dark Chrome	36 607 707-19

Required miscellaneous

Wall valve 1/2" 35 607 970 90

- min. recess depth 105 mm
- max. recess depth 150 mm



www.divapor.com

ST 010 201 0705

mm [inches]

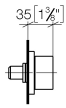
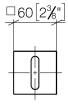

www.divapor.com

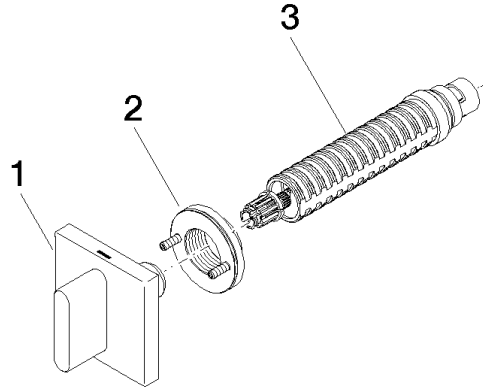

Spare parts list

No.	Item Number	Name	Quantity used	Delivery time
1	90 20 70 051 03-99	handle (hot)	1	30
2	90 21 02 108 00 90	disc	1	2
3	90 90 03 142 00 90	top	1	2