







ST 010 204 1811



- 160 mm projection
- fixed spout
- rectangular, air-enriched flow
- hole diameter 35 mm
- 1/2" connection
- max. flow 4.5 l/min
- lead-free
- automatic hygiene flush
- suitable for thermal disinfection
- adjustable follow-up time
- high-frequency sensors with self-calibration
- magnetic valve
- 100-240 V AC / 12 V DC, 50-60 Hz, 18 W power supply unit, incl. country-specific adapter set
- Cannot be combined with basins in conducting materials (e.g. steel, river stone).**
- Cannot be combined with basins that have a closing drain.**
- ATTENTION: Separate terms and conditions for electronic articles are applicable.**

	Brushed Platinum	ST 010 204 1811-06
	Chrome	ST 010 204 1811-00
	Dark Chrome	ST 010 204 1811-19
	Brushed Durabronze (23kt Gold)	ST 010 204 1811-28
	Platinum / Brushed Platinum	ST 010 204 1811-36
	Durabronze / Brushed Durabronze (23kt Gold)	ST 010 204 1811-38
	Brushed Dark Platinum	ST 010 204 1811-99

Individual components of this set

You need the following components for this set



1x 42 766 970 90



1x 13 800 811-06

www.divapor.com

ST 010 204 1811



Fits: IMO, LULU, MADISON, MEM, TARA, CL.1, LISSÉ, VAIA, META, SERIES-VARIOUS, CYO

- automatic hygiene flush
 - suitable for thermal disinfection
 - adjustable follow-up time
 - high-frequency sensors with self-calibration
 - magnetic valve
 - 100-240 V AC / 12 V DC, 50-60 Hz, 18 W power supply unit, incl. country-specific adapter set
- Cannot be combined with basins in conducting materials (e.g. steel, river stone).
Cannot be combined with basins that have a closing drain.**
- ATTENTION: Separate terms and conditions for electronic articles are applicable.**

Cannot be combined with basins in conducting materials (e.g. steel, river stone).

Cannot be combined with basins that have a closing drain.

ATTENTION: Separate terms and conditions for electronic articles are applicable.

Required miscellaneous

Required miscellaneous

	eSET Touchfree Basin mixer without temperature setting for combining with free-standing fittings	35 742 970 90
---	---	---------------

	eSET Touchfree Basin mixer without temperature setting for combining with wall-mounted fittings	35 743 970 90
	<ul style="list-style-type: none"> • min. recess depth 90 mm • max. recess depth 125 mm 	

Recommended miscellaneous

	Extension for Touchfree 500 mm	12 765 970 90
---	---------------------------------------	---------------

ST 010 204 1811

mm [inches]

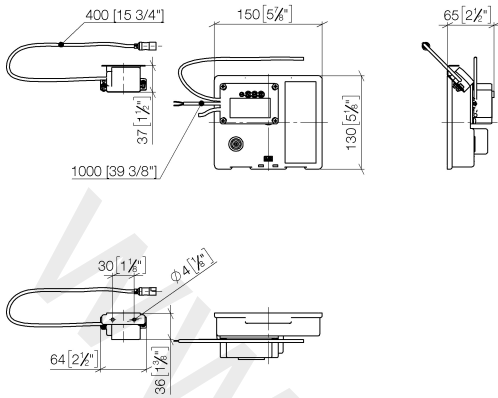

ST 010 204 1811

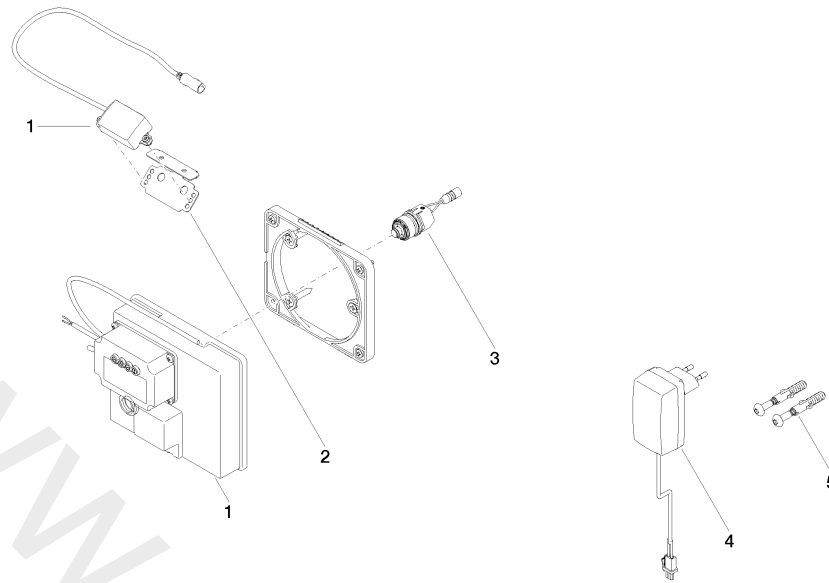







Spare parts list

No.	Item Number	Name	Quantity used	Delivery time
1	90 10 01 177 00 90	electronic accessories	1	2
2	90 17 20 199 00 90	holder	1	2
3	04 30 50 079 00 90	valve	1	2
4	04 10 01 246 00 90	electronic accessories	1	2
5	04 30 31 024 01 90	fixing set	1	2

ST 010 204 1811



- 160 mm projection
- fixed spout
- rectangular, air-enriched flow
- hole diameter 37 mm
- 1/2" connection
- max. flow 4.5 l/min
- lead-free

	Brushed Platinum	13 800 811-06
	Chrome	13 800 811-00
	Dark Chrome	13 800 811-19
	Brushed Durabross (23kt Gold)	13 800 811-28
	Platinum / Brushed Platinum	13 800 811-36
	Durabross / Brushed Durabross (23kt Gold)	13 800 811-38
	Brushed Dark Platinum	13 800 811-99

Recommended miscellaneous



- Concealed wall elbow** 35 085 970 90
- min. recess depth 90 mm
 - max. recess depth 163 mm

www.divapor.com

ST 010 204 1811

mm [inches]

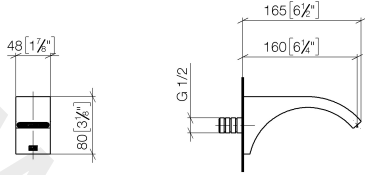

Flow rate chart

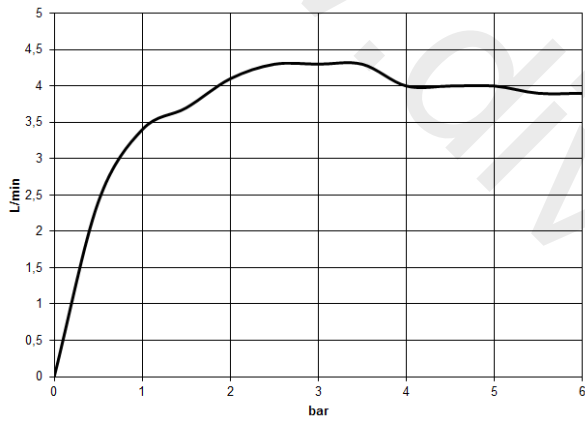

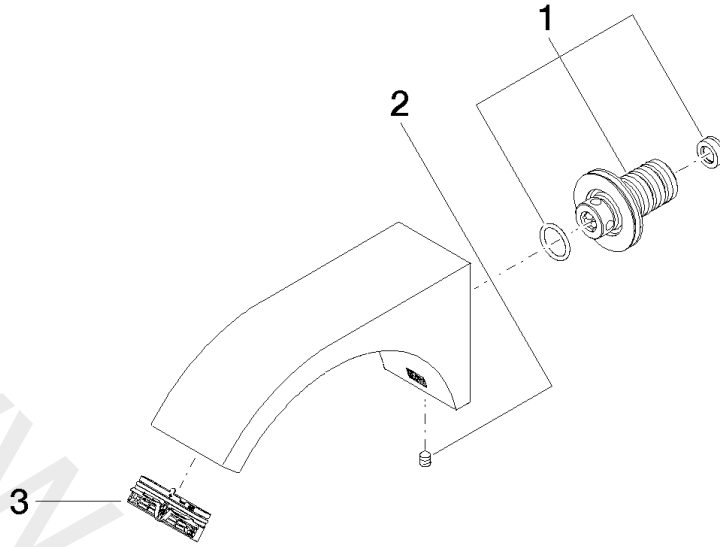

Spare parts list

No.	Item Number	Name	Quantity used	Delivery time
1	90 24 03 108 01 90	nipple set	1	2
2	04 31 11 004 00 90	pin	1	2
3	90 29 03 121 00 90	aerator	1	2