







20 000 811

- hole diameter valve 32 mm
- without rosette
- handle Ø 60mm

NOTE: The handle inserts must be ordered separately from the fittings!



	Brushed Platinum	20 000 811-06
	Chrome	20 000 811-00
	Dark Chrome	20 000 811-19
	Brushed Durabronze (23kt Gold)	20 000 811-28
	Platinum / Brushed Platinum	20 000 811-36
	Durabronze / Brushed Durabronze (23kt Gold)	20 000 811-38
	Brushed Dark Platinum	20 000 811-99

20 000 811

mm [inches]

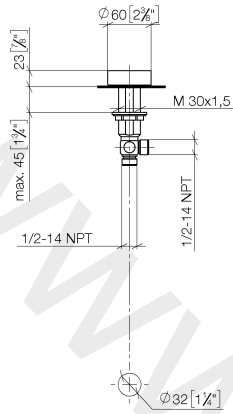

20 000 811

Parts for other
finishes can be found
here: [Chrome](#)

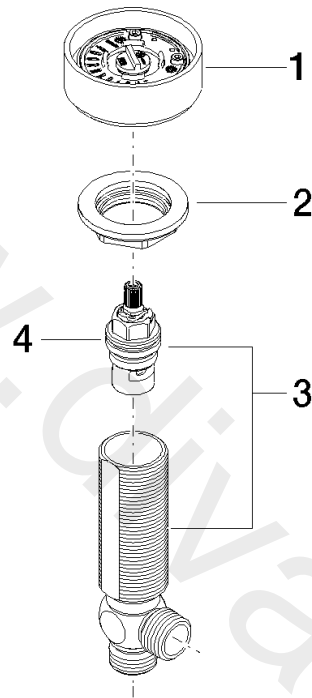

Spare parts list

No.	Item Number	Name	Quantity used	Delivery time
2	90 18 40 291 01-06	handle	1	10
3	04 30 11 038 68 90	fixing set	1	2
4	04 17 11 055 61 90	side panel	2	2