





ST 060 112 2740



- cover plate Ø 124 mm
 - handle Ø 60mm
 - without rosette
 - temperature control handle with safety limit stop at 38°C
 - thermostat cartridge
 - 2x head part with cut-to-length spindle and sleeve
- Note: Important! The minimum recess depths make it necessary to have a wall of 2 x 6 crosspieces.**
Fits META

	Matte Black	ST 060 112 2740-33
	Chrome	ST 060 112 2740-00
	Brushed Platinum	ST 060 112 2740-06
	Brushed Chrome	ST 060 112 2740-93

Individual components of this set

You need the following components for this set



1x 36 503 979-33



2x 36 607 740-33

www.divapor.com

ST 060 112 2740



- cover plate Ø 124 mm
- temperature control handle with safety limit stop at 38°C
- thermostat cartridge

Codes & standards

	Matte Black	36 503 979-33
	Chrome	36 503 979-00
	Brushed Platinum	36 503 979-06
	Platinum	36 503 979-08
	Durabress (23kt Gold)	36 503 979-09
	Matte White	36 503 979-10
	Dark Chrome	36 503 979-19
	Brushed Durabress (23kt Gold)	36 503 979-28
	Brushed Champagne (22kt Gold)	36 503 979-46
	Champagne (22kt Gold)	36 503 979-47
	Brushed Chrome	36 503 979-93
	Brushed Dark Platinum	36 503 979-99

Required miscellaneous



xTOOL Concealed thermostat module without volume control 35 503 970 90
 • min. recess depth 85 mm
 • max. recess depth 110 mm

Recommended miscellaneous



xGRID Attachment set for integrating in the dry wall construction 12 340 970 90

Required miscellaneous



xGRID Installation track 555 mm 12 360 970 90

ST 060 112 2740

mm [inches]

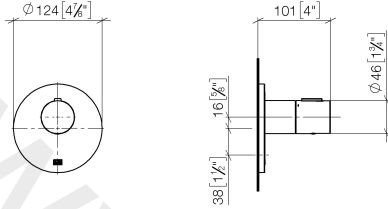

www.divapor.com

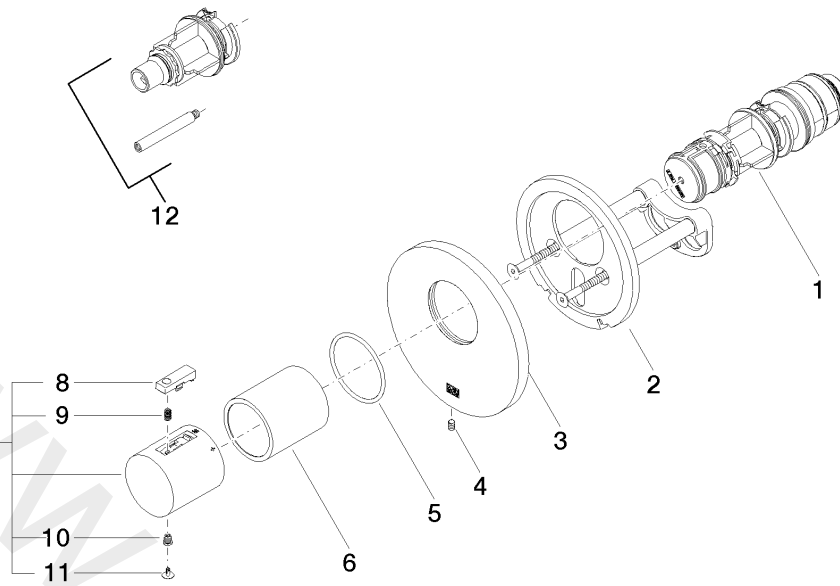

Spare parts list

No.	Item Number	Name	Quantity used	Delivery time
1	90 15 02 065 00 90	cartridge	1	2
2	90 11 01 196 00 90	base	1	2
3	09 11 02 537-33	cover	1	30
4	09 31 11 048 90	pin	1	2
5	09 14 10 049 90	seal	1	2
6	09 21 02 112-33	sleeve	1	30
7	90 17 33 004 00-33	handle	1	30
8	90 21 33 010 00-13	handle	1	2
9	90 16 02 027 00 90	spring	1	2
10	09 30 30 136 90	screw	1	2
11	09 31 20 049-13	plug	1	30
12	12 178 970 90	Extension 46 mm	1	2

ST 060 112 2740









- without rosette
- handle Ø 60mm
- without marking
- head part with cut-to-length spindle and sleeve

Codes & standards

Fits CL.1, META, CYO

Fits: CL.1, META, CYO

Fits CL.1, META, CYO

	Matte Black	36 607 740-33
	Chrome	36 607 740-00
	Brushed Platinum	36 607 740-06
	Dark Chrome	36 607 740-19
	Brushed Durabronze (23kt Gold)	36 607 740-28
	Brushed Chrome	36 607 740-93
	Brushed Dark Platinum	36 607 740-99

Required miscellaneous



- Wall valve 1/2"** 35 607 970 90
- min. recess depth 85 mm
 - max. recess depth 145 mm

www.divapor.com

ST 060 112 2740

mm [inches]

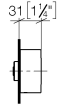

www.divapor.com

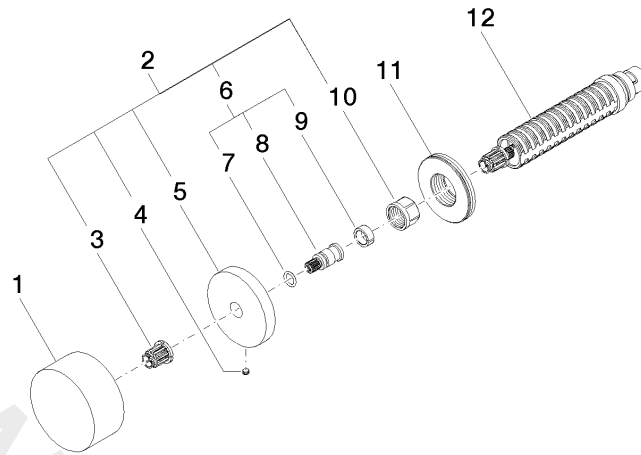

Spare parts list

No.	Item Number	Name	Quantity used	Delivery time
1	09 20 74 004-33	handle	1	30
2	04 27 74 004 00-33	rosette	1	30
3	90 12 12 002 00 90	fixing cap	1	2
4	09 31 11 055 90	pin	1	2
5	09 27 74 004-33	rosette	1	30
6	04 29 06 020 00-00	spindle	1	10
7	09 14 10 060 90	seal	1	2
8	09 29 06 020-33	spindle	1	-
9	09 14 15 020 90	ring	1	2
10	09 23 30 023 90	nut	1	2
11	09 30 01 107 90	sleeve	1	2
12	90 90 03 143 00 90	top	1	2