







ST 050 302 2809



- shower with fixed riser projection 450 mm
- overhead shower: rain flow
- rain shower Ø 300 mm
- rain shower with anti-scale system
- max. rainshower flow 14 l/min
- hand shower: normal flow
- max. hand shower flow 15 l/min
- rotary diverter for fixed-riser shower/hand shower
- rosette for shower holder Ø 60mm
- slide-on rosettes Ø 60 mm
- gauge 150 mm - 13 mm
- 1500 mm metal shower hose
- 1/2" connection
- Pipe diameter 23.5 mm

	Brushed Dark Platinum	ST 050 302 2809-99
	Chrome	ST 050 302 2809-00
	Brushed Platinum	ST 050 302 2809-06
	Platinum	ST 050 302 2809-08
	Dark Chrome	ST 050 302 2809-19
	Brushed Durabronze (23kt Gold)	ST 050 302 2809-28

Individual components of this set

You need the following components for this set



1x 26 632 809-99



1x 28 019 979-99

www.divapor.com

ST 050 302 2809



- shower with fixed riser projection 450 mm
- overhead shower: rain flow
- rain shower Ø 300 mm
- rain shower with anti-scale system
- max. rainshower flow 14 l/min
- rotary diverter for fixed-riser shower/hand shower
- rosette for shower holder Ø 60mm
- slide-on rosettes Ø 60 mm
- gauge 150 mm - 13 mm
- 1500 mm metal shower hose
- 1/2" connection
- Pipe diameter 23.5 mm
- quick clearing

	Brushed Dark Platinum	26 632 809-99
	Chrome	26 632 809-00
	Brushed Platinum	26 632 809-06
	Platinum	26 632 809-08
	Brushed Durabronz (23kt Gold)	26 632 809-28

This article does not include a hand shower!

Fits VAIA

Required miscellaneous

	Hand shower	28 015 979-99
---	--------------------	---------------

Required miscellaneous

	Hand shower	28 015 979-99 0010
---	--------------------	-----------------------

Required miscellaneous

	Hand shower	28 012 979-99 0010
--	--------------------	-----------------------

Required miscellaneous

	Hand shower	28 017 979-99
--	--------------------	---------------

Required miscellaneous

	Hand shower	28 016 979-99
---	--------------------	---------------

Required miscellaneous

	Hand shower	28 012 979-99
---	--------------------	---------------

Required miscellaneous

	Hand shower	28 017 979-99 0010
---	--------------------	-----------------------

Required miscellaneous

	Hand shower	28 016 979-99 0010
---	--------------------	-----------------------

Required miscellaneous

	Hand shower	28 018 979-99
---	--------------------	---------------

Required miscellaneous

	Hand shower	28 018 979-99 0010
---	--------------------	-----------------------

ST 050 302 2809

Parts for other finishes can be found here: [Chrome](#)

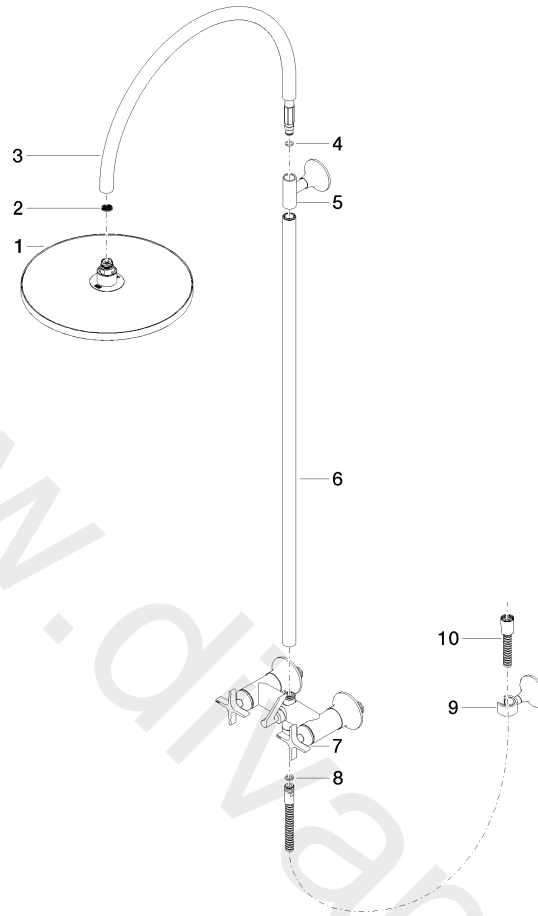

Spare parts list

No.	Item Number	Name	Quantity used	Delivery time
1	04 12 05 091 00-99	shower	1	30
2	09 23 01 039 90	sieve	1	2
3	04 28 22 346 00-99	pipe	1	30
4	09 14 10 008 90	seal	1	2
5	90 17 11 148 00-99	holder	1	30
6	04 28 22 349 00-99	pipe	1	30
7	04 17 10 020 03-99	fitting	1	30
8	09 14 20 026 90	seal	1	2
9	28 050 809-99	Wall bracket	1	30
10	28 304 970-99	Metal shower hose 1/2" x 3/8" x 1500 mm	1	30

ST 050 302 2809







- normal flow
- with anti-scale system
- 1/2" connection
- max. flow 15 l/min
- WRAS: 2112017

Intrinsic protection against back flow.

Fits MEM, CL.1, IMO, META, TARA, VAIA, LULU, LISSÉ, CYO

Fits: IMO, LULU, MADISON, MEM, TARA, CL.1, LISSÉ, VAIA, META, SERIES-VARIOUS, CYO

	Brushed Dark Platinum	28 019 979-99
	Chrome	28 019 979-00
	Brushed Platinum	28 019 979-06
	Platinum	28 019 979-08
	Matte White	28 019 979-10
	Dark Chrome	28 019 979-19
	Brushed Durabross (23kt Gold)	28 019 979-28
	Matte Black	28 019 979-33
	Brushed Champagne (22kt Gold)	28 019 979-46
	Champagne (22kt Gold)	28 019 979-47
	Brushed Chrome	28 019 979-93

www.divapor.com

ST 050 302 2809

mm [inches]

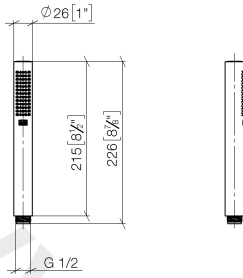

Flow rate chart

