

ST 060 108 9811

- cover plate 120 x 120 mm
 - handle Ø 60mm
 - temperature control handle with safety limit stop at 38°C
 - thermostat cartridge
 - head part with cut-to-length spindle and sleeve
- 36 501 985-FF can also be used as an alternative.**
Note: Important! The minimum recess depths make it necessary to have a wall of 2 x 6 crosspieces.



	Brushed Dark Platinum	ST 060 108 9811-99
	Chrome	ST 060 108 9811-00
	Brushed Platinum	ST 060 108 9811-06
	Dark Chrome	ST 060 108 9811-19
	Brushed Durabronz (23kt Gold)	ST 060 108 9811-28

Individual components of this set

You need the following components for this set



1x 36 501 780-99



1x 36 607 811-99



1x 11 187 811-99

www.divapor.com

ST 060 108 9811



Fits: DEQUE, IMO, MEM, SYMETRICS, CL.1, SERIES-VARIOUS, CYO

- cover plate 120 x 120 mm
- temperature control handle with safety limit stop at 38°C
- thermostat cartridge

Codes & standards

Fits MEM, CL.1, CYO

Note: Important! The minimum recess depths make it necessary to have a wall of 2 x 6 crosspieces.

Fits MEM, CL.1, CYO

Note: Important! The minimum recess depths make it necessary to have a wall of 2 x 6 crosspieces.

	Brushed Dark Platinum	36 501 780-99
	Chrome	36 501 780-00
	Brushed Platinum	36 501 780-06
	Platinum	36 501 780-08
	Dark Chrome	36 501 780-19
	Brushed Durabronz (23kt Gold)	36 501 780-28
	Matte Black	36 501 780-33
	Brushed Chrome	36 501 780-93

Required miscellaneous



xTOOL Concealed thermostat module without volume control 35 503 970 90
 •min. recess depth 115 mm
 •max. recess depth 155 mm

Recommended miscellaneous



xGRID Attachment set for integrating in the dry wall construction 12 340 970 90

Required miscellaneous



xGRID Installation track 555 mm 12 360 970 90

ST 060 108 9811

mm [inches]

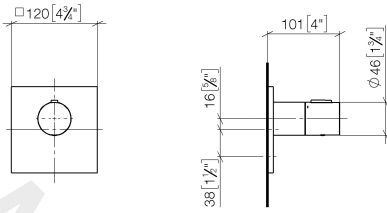

www.divapor.com

ST 060 108 9811

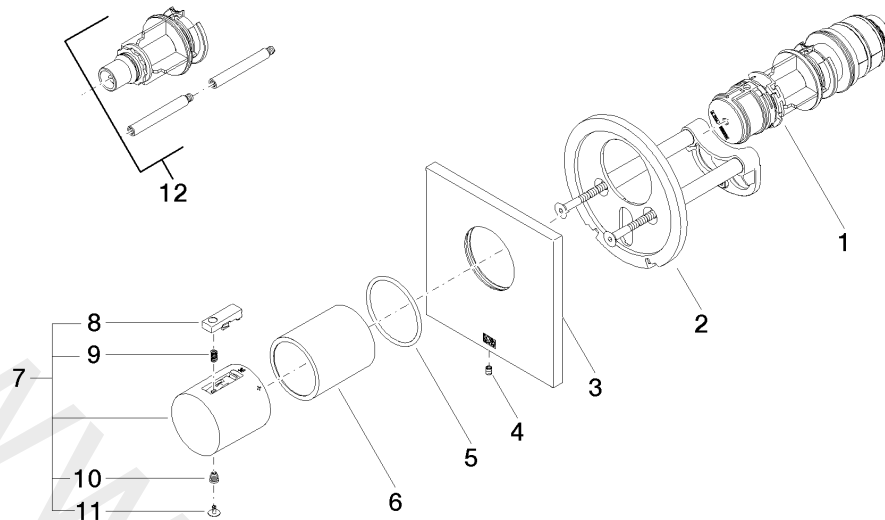

Spare parts list

No.	Item Number	Name	Quantity used	Delivery time
1	90 15 02 063 00 90	cartridge	1	2
2	90 11 01 196 00 90	base	1	2
3	09 11 02 533-99	cover	1	30
4	09 31 11 044 90	pin	1	2
5	09 14 10 049 90	seal	1	2
6	09 21 02 112-99	sleeve	1	30
7	90 17 33 004 00-99	handle	1	30
8	90 21 33 010 00-13	handle	1	2
9	90 16 02 027 00 90	spring	1	2
10	09 30 30 136 90	screw	1	2
11	09 31 20 049-13	plug	1	30
12	12 178 970 90	Extension 46 mm	1	2







ST 060 108 9811



- without rosette
- handle Ø 60mm
- head part with cut-to-length spindle and sleeve

Fits CYO

NOTE: The handle inserts must be ordered separately from the fittings!

	Brushed Dark Platinum	36 607 811-99
	Chrome	36 607 811-00
	Brushed Platinum	36 607 811-06
	Dark Chrome	36 607 811-19
	Brushed Durabronze (23kt Gold)	36 607 811-28
	Platinum / Brushed Platinum	36 607 811-36
	Durabronze / Brushed Durabronze (23kt Gold)	36 607 811-38

www.divapor.com

www.divapor.com

ST 060 108 9811

mm [inches]

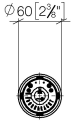

www.divapor.com

ST 060 108 9811

Parts for other
finishes can be found
here: [Chrome](#)

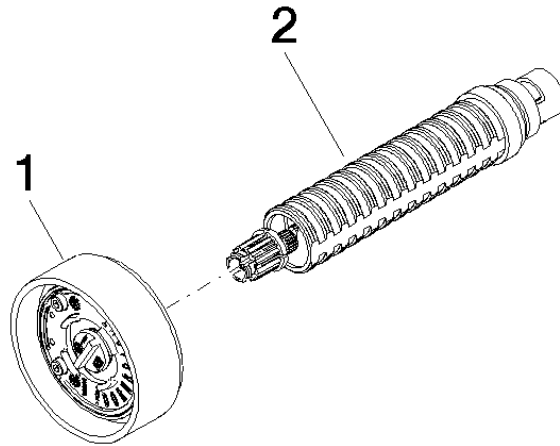







Spare parts list

No.	Item Number	Name	Quantity used	Delivery time
1	90 18 40 291 01-99	handle	1	30
2	90 90 03 172 01 90	top	1	2

ST 060 108 9811

• without marking



	Brushed Dark Platinum	11 187 811-99
	Chrome	11 187 811-00
	Brushed Platinum	11 187 811-06
	Platinum	11 187 811-08
	Durabress (23kt Gold)	11 187 811-09
	Dark Chrome	11 187 811-19
	Brushed Durabress (23kt Gold)	11 187 811-28

www.divapor.com

www.divapor.com

ST 060 108 9811

mm [inches]

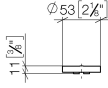

www.divapor.com

www.divapor.com

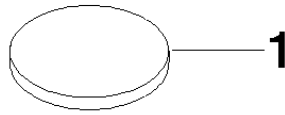

www.divapor.com

www.divapor.com