





ST 060 111 2980



- cover plate 120 x 120 mm
- rosette 60 x 60 mm
- temperature control handle with safety limit stop at 38°C
- thermostat cartridge
- 2x head part with cut-to-length spindle and sleeve

Note: Important! The minimum recess depths make it necessary to have a wall of 2 x 6 crosspieces.

Fits: IMO, SYMETRICS

	Brushed Dark Platinum	ST 060 111 2980-99
	Chrome	ST 060 111 2980-00
	Brushed Platinum	ST 060 111 2980-06
	Platinum	ST 060 111 2980-08
	Brushed Durabronze (23kt Gold)	ST 060 111 2980-28
	Brushed Chrome	ST 060 111 2980-93

Individual components of this set

You need the following components for this set

1x 36 503 780-99



2x 36 607 980-99



www.divapor.com

ST 060 111 2980



Fits: IMO, MEM, CL.1, CYO

- cover plate 120 x 120 mm
- temperature control handle with safety limit stop at 38°C
- thermostat cartridge

Codes & standards

Note: Important! The minimum recess depths make it necessary to have a wall of 2 x 6 crosspieces.

Note: Important! The minimum recess depths make it necessary to have a wall of 2 x 6 crosspieces.

	Brushed Dark Platinum	36 503 780-99
	Chrome	36 503 780-00
	Brushed Platinum	36 503 780-06
	Platinum	36 503 780-08
	Dark Chrome	36 503 780-19
	Brushed Durabass (23kt Gold)	36 503 780-28
	Matte Black	36 503 780-33
	Brushed Champagne (22kt Gold)	36 503 780-46
	Champagne (22kt Gold)	36 503 780-47
	Brushed Chrome	36 503 780-93

Required miscellaneous



xTOOL Concealed thermostat module without volume control 35 503 970 90
 •min. recess depth 115 mm
 •max. recess depth 155 mm

Recommended miscellaneous



xGRID Attachment set for integrating in the dry wall construction 12 340 970 90

Required miscellaneous



xGRID Installation track 555 mm 12 360 970 90

ST 060 111 2980

mm [inches]

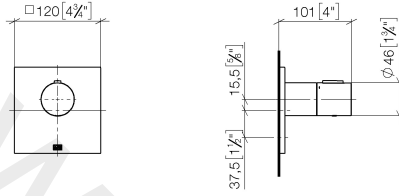

www.divapor.com

ST 060 111 2980

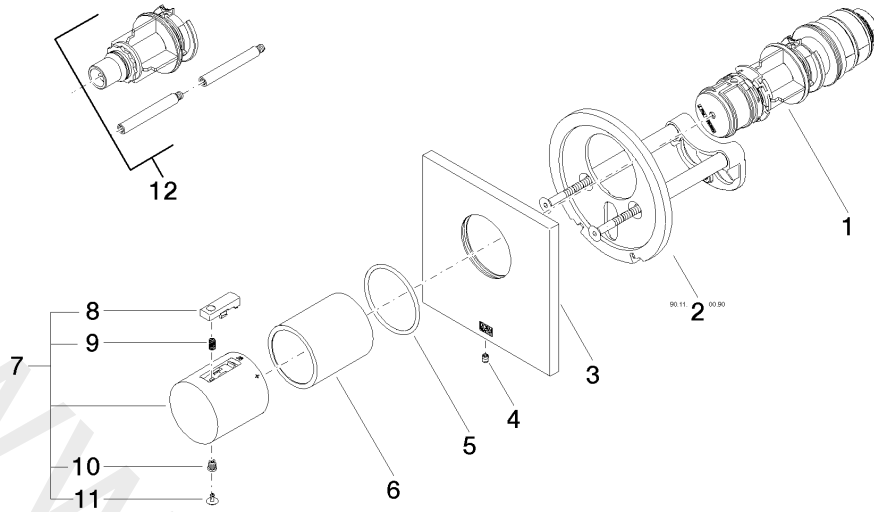

Spare parts list

No.	Item Number	Name	Quantity used	Delivery time
1	90 15 02 065 00 90	cartridge	1	2
2	90 11 01 196 00 90	base	1	2
3	09 11 02 533-99	cover	1	30
4	09 31 11 044 90	pin	1	2
5	09 14 10 049 90	seal	1	2
6	09 21 02 112-99	sleeve	1	30
7	90 17 33 004 00-99	handle	1	30
8	90 21 33 010 00-13	handle	1	2
9	90 16 02 027 00 90	spring	1	2
10	09 30 30 136 90	screw	1	2
11	09 31 20 049-13	plug	1	30
12	12 178 970 90	Extension 46 mm	1	2

ST 060 111 2980









- rosette 60 x 60 mm
- head part with cut-to-length spindle and sleeve

Codes & standards

Fits IMO

Fits IMO

Fits: IMO, SYMETRICS

	Brushed Dark Platinum	36 607 980-99
	Chrome	36 607 980-00
	Brushed Platinum	36 607 980-06
	Platinum	36 607 980-08
	Brushed Durabronze (23kt Gold)	36 607 980-28
	Brushed Chrome	36 607 980-93

Required miscellaneous



Wall valve 1/2"

35 607 970 90

- min. recess depth 75 mm
- max. recess depth 145 mm

www.divapor.com

ST 060 111 2980

mm [inches]

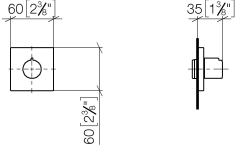

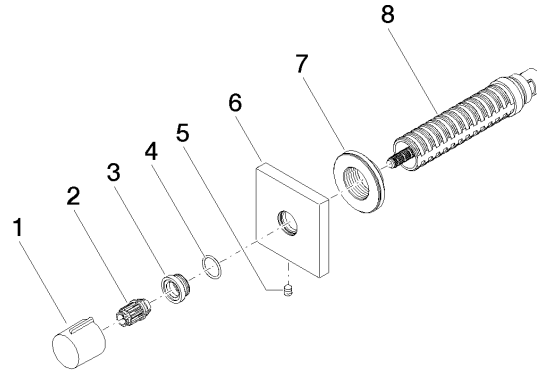

Spare parts list

No.	Item Number	Name	Quantity used	Delivery time
1	09 20 98 001-99	handle	1	30
2	09 12 12 005 90	fixing cap	1	2
3	09 12 12 043-99	base	1	30
4	09 14 10 017 90	seal	1	2
5	04 31 11 004 00 90	pin	1	2
6	09 27 98 014-99	rosette	1	30
7	09 21 02 151 90	sleeve	1	2
8	90 90 03 202 00 90	top	1	2