







ST 060 113 2985



- cover plate 120 x 120 mm
- rosette 60 x 60 mm
- temperature control handle with safety limit stop at 38°C
- thermostat cartridge
- 2x head part with cut-to-length spindle and sleeve

Fits: IMO, SYMETRICS

	Brushed Dark Platinum	ST 060 113 2985-99
	Chrome	ST 060 113 2985-00
	Brushed Platinum	ST 060 113 2985-06
	Platinum	ST 060 113 2985-08
	Brushed Durabronze (23kt Gold)	ST 060 113 2985-28
	Brushed Chrome	ST 060 113 2985-93

Individual components of this set

You need the following components for this set



1x 36 503 985-99



2x 36 607 985-99

www.divapor.com

ST 060 113 2985



Fits: IMO, MEM, CL.1, CYO

- cover plate 120 x 120 mm
- temperature control handle with safety limit stop at 38°C
- thermostat cartridge

Codes & standards

Note: Important! The minimum recess depths make it necessary to have a wall of 2 x 6 crosspieces.

Note: Important! The minimum recess depths make it necessary to have a wall of 2 x 6 crosspieces.

	Brushed Dark Platinum	36 503 985-99
	Chrome	36 503 985-00
	Brushed Platinum	36 503 985-06
	Platinum	36 503 985-08
	Dark Chrome	36 503 985-19
	Brushed Durabress (23kt Gold)	36 503 985-28
	Matte Black	36 503 985-33
	Brushed Champagne (22kt Gold)	36 503 985-46
	Champagne (22kt Gold)	36 503 985-47
	Brushed Chrome	36 503 985-93

Required miscellaneous



xTOOL Concealed thermostat module without volume control 35 503 970 90
 •min. recess depth 95 mm
 •max. recess depth 160 mm

Recommended miscellaneous



xGRID Attachment set for integrating in the dry wall construction 12 340 970 90

Required miscellaneous



xGRID Installation track 555 mm 12 360 970 90

ST 060 113 2985

mm [inches]

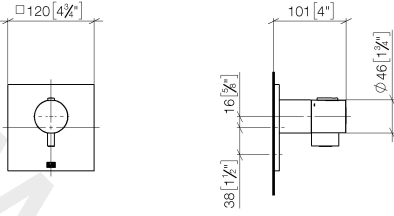

www.divapor.com

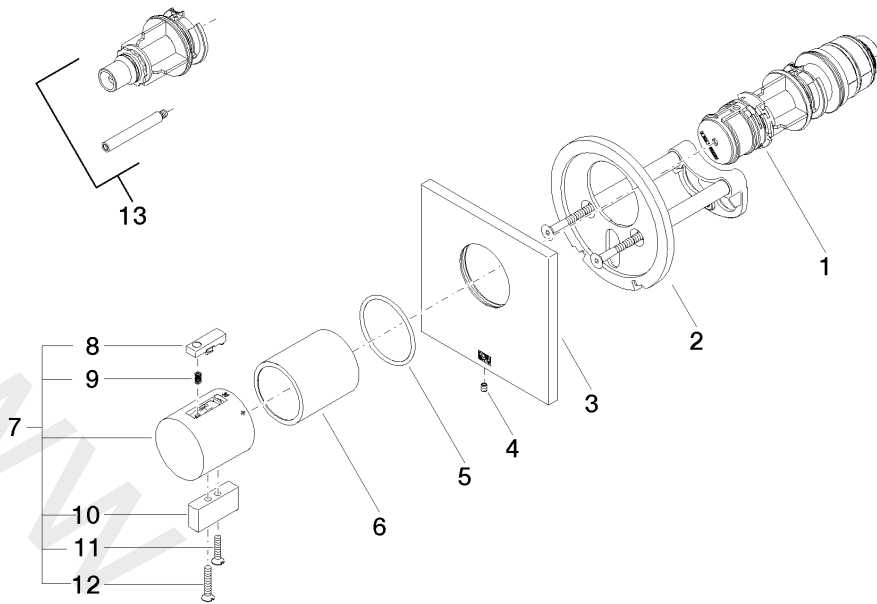

Spare parts list

No.	Item Number	Name	Quantity used	Delivery time
1	90 15 02 065 00 90	cartridge	1	2
2	90 11 01 196 00 90	base	1	2
3	09 11 02 533-99	cover	1	30
4	09 31 11 044 90	pin	1	2
5	09 14 10 049 90	seal	1	2
6	09 21 02 112-99	sleeve	1	30
7	04 17 33 006 00-99	handle	1	60
8	90 21 33 010 00-13	handle	1	2
9	90 16 02 027 00 90	spring	1	2
10	09 20 33 006-99	handle	1	30
11	09 30 30 159-99	screw	1	30
12	09 30 30 160-99	screw	1	30
13	12 178 970 90	Extension 46 mm	1	2

ST 060 113 2985

- rosette 60 x 60 mm
- head part with cut-to-length spindle and sleeve









Codes & standards

Fits IMO

Fits IMO

Fits: IMO, SYMETRICS

	Brushed Dark Platinum	36 607 985-99
	Chrome	36 607 985-00
	Brushed Platinum	36 607 985-06
	Platinum	36 607 985-08
	Brushed Durabronze (23kt Gold)	36 607 985-28
	Brushed Chrome	36 607 985-93

Required miscellaneous



Wall valve 1/2"

35 607 970 90

- min. recess depth 75 mm
- max. recess depth 145 mm

www.divapor.com

ST 060 113 2985

mm [inches]

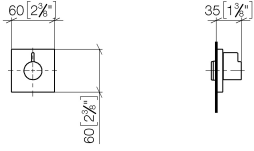

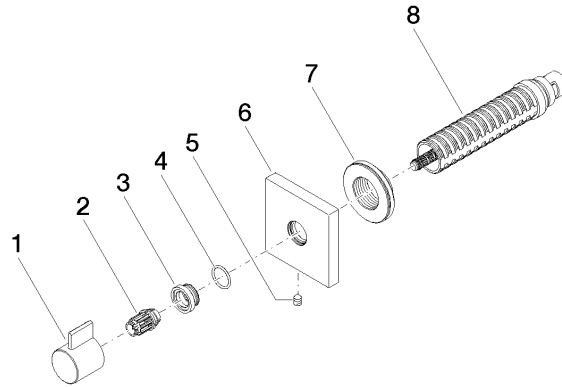

Spare parts list

No.	Item Number	Name	Quantity used	Delivery time
1	09 20 98 002-99	handle	1	30
2	09 12 12 005 90	fixing cap	1	2
3	09 12 12 043-99	base	1	30
4	09 14 10 017 90	seal	1	2
5	04 31 11 004 00 90	pin	1	2
6	09 27 98 014-99	rosette	1	30
7	09 21 02 151 90	sleeve	1	2
8	90 90 03 202 00 90	top	1	2