

ST 060 111 1811



- cover plate 120 x 120 mm
  - handle Ø 60mm
  - temperature control handle with safety limit stop at 38°C
  - thermostat cartridge
  - 3x head part with cut-to-length spindle and sleeve
- 36 503 985-FF can also be used as an alternative.**  
**Note: Important! The minimum recess depths make it necessary to have a wall of 2 x 6 crosspieces.**

	Brushed Dark Platinum	ST 060 111 1811-99
	Chrome	ST 060 111 1811-00
	Brushed Platinum	ST 060 111 1811-06
	Dark Chrome	ST 060 111 1811-19
	Brushed Durabronz (23kt Gold)	ST 060 111 1811-28

Individual components of this set

You need the following components for this set



1x 36 503 780-99



3x 36 607 811-99



3x 11 187 811-99

www.divapor.com

ST 060 111 1811



Fits: IMO, MEM, CL.1, CYO

- cover plate 120 x 120 mm
- temperature control handle with safety limit stop at 38°C
- thermostat cartridge

**Codes & standards**

**Note: Important! The minimum recess depths make it necessary to have a wall of 2 x 6 crosspieces.**

Note: Important! The minimum recess depths make it necessary to have a wall of 2 x 6 crosspieces.

	Brushed Dark Platinum	36 503 780-99
	Chrome	36 503 780-00
	Brushed Platinum	36 503 780-06
	Platinum	36 503 780-08
	Dark Chrome	36 503 780-19
	Brushed Durabass (23kt Gold)	36 503 780-28
	Matte Black	36 503 780-33
	Brushed Champagne (22kt Gold)	36 503 780-46
	Champagne (22kt Gold)	36 503 780-47
	Brushed Chrome	36 503 780-93

**Required miscellaneous**



**xTOOL Concealed thermostat module without volume control** 35 503 970 90  
 •min. recess depth 115 mm  
 •max. recess depth 155 mm

**Recommended miscellaneous**



**xGRID Attachment set for integrating in the dry wall construction** 12 340 970 90

**Required miscellaneous**



**xGRID Installation track 555 mm** 12 360 970 90

ST 060 111 1811

mm [inches]

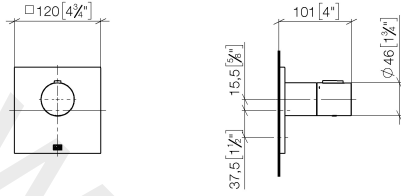

www.divapor.com

ST 060 111 1811

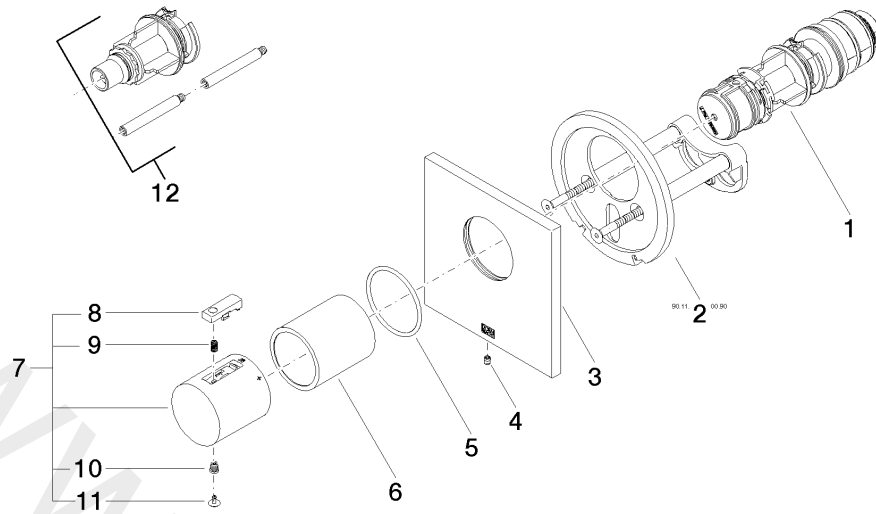

Spare parts list

No.	Item Number	Name	Quantity used	Delivery time
1	90 15 02 065 00 90	cartridge	1	2
2	90 11 01 196 00 90	base	1	2
3	09 11 02 533-99	cover	1	30
4	09 31 11 044 90	pin	1	2
5	09 14 10 049 90	seal	1	2
6	09 21 02 112-99	sleeve	1	30
7	90 17 33 004 00-99	handle	1	30
8	90 21 33 010 00-13	handle	1	2
9	90 16 02 027 00 90	spring	1	2
10	09 30 30 136 90	screw	1	2
11	09 31 20 049-13	plug	1	30
12	12 178 970 90	Extension 46 mm	1	2







ST 060 111 1811



- without rosette
- handle Ø 60mm
- head part with cut-to-length spindle and sleeve

Fits CYO

NOTE: The handle inserts must be ordered separately from the fittings!

	Brushed Dark Platinum	36 607 811-99
	Chrome	36 607 811-00
	Brushed Platinum	36 607 811-06
	Dark Chrome	36 607 811-19
	Brushed Durabronze (23kt Gold)	36 607 811-28
	Platinum / Brushed Platinum	36 607 811-36
	Durabronze / Brushed Durabronze (23kt Gold)	36 607 811-38

www.divapor.com

www.divapor.com

ST 060 111 1811

mm [inches]

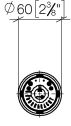

www.divapor.com

ST 060 111 1811

Parts for other  
finishes can be found  
here: [Chrome](#)

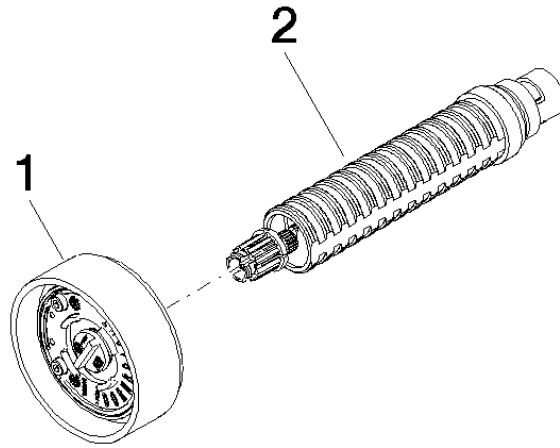







Spare parts list

No.	Item Number	Name	Quantity used	Delivery time
1	90 18 40 291 01-99	handle	1	30
2	90 90 03 172 01 90	top	1	2

ST 060 111 1811

• without marking



	Brushed Dark Platinum	11 187 811-99
	Chrome	11 187 811-00
	Brushed Platinum	11 187 811-06
	Platinum	11 187 811-08
	Durabress (23kt Gold)	11 187 811-09
	Dark Chrome	11 187 811-19
	Brushed Durabress (23kt Gold)	11 187 811-28

www.divapor.com

www.divapor.com

ST 060 111 1811

mm [inches]

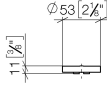

www.divapor.com

www.divapor.com

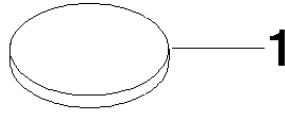

www.divapor.com

www.divapor.com