







ST 060 113 2985



- cover plate 120 x 120 mm
- rosette 60 x 60 mm
- temperature control handle with safety limit stop at 38°C
- thermostat cartridge
- 2x head part with cut-to-length spindle and sleeve

Fits: IMO, SYMETRICS

	Brushed Dark Platinum	ST 060 113 2985-99
	Chrome	ST 060 113 2985-00
	Brushed Platinum	ST 060 113 2985-06
	Platinum	ST 060 113 2985-08
	Brushed Durabronze (23kt Gold)	ST 060 113 2985-28
	Brushed Chrome	ST 060 113 2985-93

Individual components of this set

You need the following components for this set



1x 36 503 985-99



2x 36 607 985-99

www.divapor.com

ST 060 113 2985



Fits: IMO, MEM, CL.1, CYO

- cover plate 120 x 120 mm
- temperature control handle with safety limit stop at 38°C
- thermostat cartridge

**Codes & standards**

**Note: Important! The minimum recess depths make it necessary to have a wall of 2 x 6 crosspieces.**

Note: Important! The minimum recess depths make it necessary to have a wall of 2 x 6 crosspieces.

	Brushed Dark Platinum	36 503 985-99
	Chrome	36 503 985-00
	Brushed Platinum	36 503 985-06
	Platinum	36 503 985-08
	Dark Chrome	36 503 985-19
	Brushed Durabass (23kt Gold)	36 503 985-28
	Matte Black	36 503 985-33
	Brushed Champagne (22kt Gold)	36 503 985-46
	Champagne (22kt Gold)	36 503 985-47
	Brushed Chrome	36 503 985-93

**Required miscellaneous**



**xTOOL Concealed thermostat module without volume control** 35 503 970 90  
 •min. recess depth 95 mm  
 •max. recess depth 160 mm

**Recommended miscellaneous**



**xGRID Attachment set for integrating in the dry wall construction** 12 340 970 90

**Required miscellaneous**



**xGRID Installation track 555 mm** 12 360 970 90

ST 060 113 2985

mm [inches]

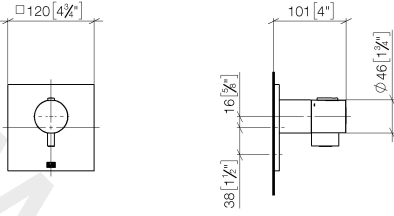

www.divapor.com

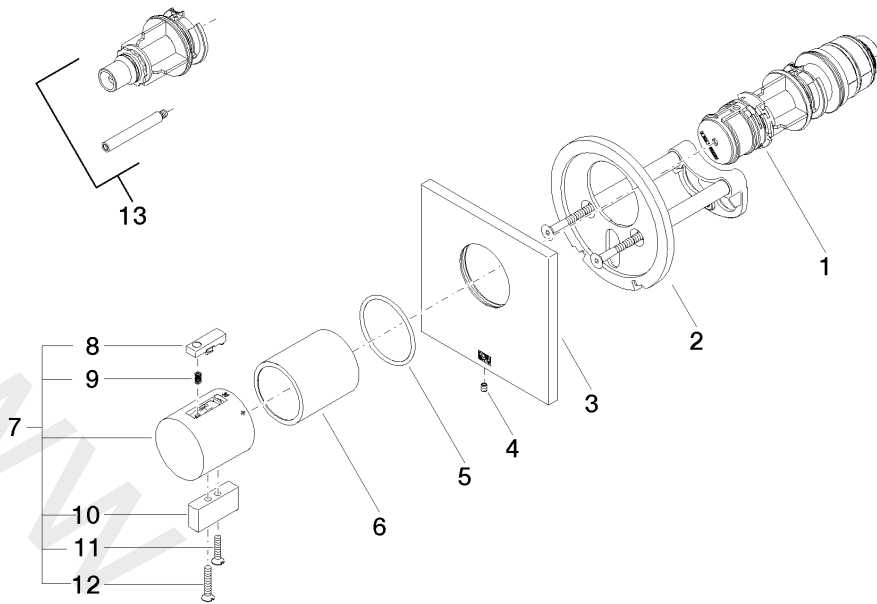

Spare parts list

No.	Item Number	Name	Quantity used	Delivery time
1	90 15 02 065 00 90	cartridge	1	2
2	90 11 01 196 00 90	base	1	2
3	09 11 02 533-99	cover	1	30
4	09 31 11 044 90	pin	1	2
5	09 14 10 049 90	seal	1	2
6	09 21 02 112-99	sleeve	1	30
7	04 17 33 006 00-99	handle	1	60
8	90 21 33 010 00-13	handle	1	2
9	90 16 02 027 00 90	spring	1	2
10	09 20 33 006-99	handle	1	30
11	09 30 30 159-99	screw	1	30
12	09 30 30 160-99	screw	1	30
13	12 178 970 90	Extension 46 mm	1	2

ST 060 113 2985









- rosette 60 x 60 mm
- head part with cut-to-length spindle and sleeve

**Codes & standards**

**Fits IMO**

Fits IMO

Fits: IMO, SYMETRICS

	Brushed Dark Platinum	36 607 985-99
	Chrome	36 607 985-00
	Brushed Platinum	36 607 985-06
	Platinum	36 607 985-08
	Brushed Durabronze (23kt Gold)	36 607 985-28
	Brushed Chrome	36 607 985-93

**Required miscellaneous**



- Wall valve 1/2"** 35 607 970 90
- min. recess depth 75 mm
  - max. recess depth 145 mm

www.divapor.com

ST 060 113 2985

mm [inches]

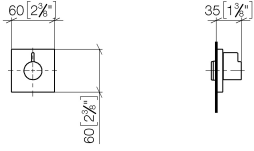

www.divapor.com

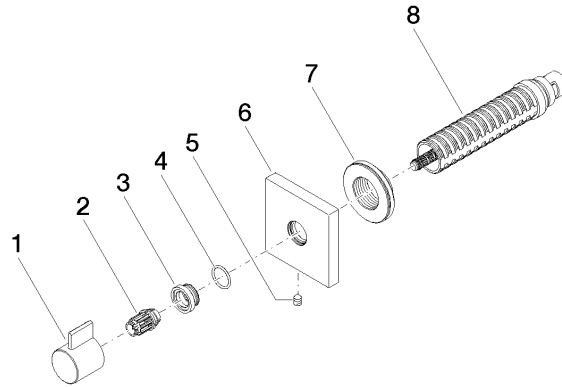

Spare parts list

No.	Item Number	Name	Quantity used	Delivery time
1	09 20 98 002-99	handle	1	30
2	09 12 12 005 90	fixing cap	1	2
3	09 12 12 043-99	base	1	30
4	09 14 10 017 90	seal	1	2
5	04 31 11 004 00 90	pin	1	2
6	09 27 98 014-99	rosette	1	30
7	09 21 02 151 90	sleeve	1	2
8	90 90 03 202 00 90	top	1	2