





ST 050 306 7979



Fits: IMO, LULU, TARA, LISSÉ, VAIA, META, SERIES-VARIOUS, CYO

- shower with fixed riser projection 450 mm
 - overhead shower: rain flow
 - rain shower Ø 220 mm
 - rain shower with anti-scale system
 - max. rainshower flow 8.6 l/min
 - hand shower: normal flow
 - spray head Ø 100mm
 - max. hand shower flow 15 l/min
 - height of fittings up to rain shower (bottom edge) 985mm
 - height of fittings up to top edge of elbow 1170mm
 - metal shower hose 1750mm with integrated anti-twist protection
 - 1/2" connection
 - slide bar
 - Pipe diameter 23.5 mm
 - automatic diverter for fixed-riser shower/hand shower
- Fits IMO, META, TARA, VAIA, LISSÉ, LULU**
- Intrinsic protection against back flow.**
- Product change as of 1.4.2023: max. flow 14 l/min**

	Platinum	ST 050 306 7979-08
	Chrome	ST 050 306 7979-00
	Brushed Platinum	ST 050 306 7979-06
	Dark Chrome	ST 050 306 7979-19
	Brushed Durabronz (23kt Gold)	ST 050 306 7979-28
	Matte Black	ST 050 306 7979-33
	Brushed Dark Platinum	ST 050 306 7979-99

Individual components of this set

You need the following components for this set



1x 28 015 979-08



1x 36 112 970-08

www.divapor.com

ST 050 306 7979



- normal flow
- with anti-scale system
- spray head Ø 100mm
- 1/2" connection
- max. flow 15 l/min
- This product can help a building to meet requirements of Green Building Rating Systems, e.g. LEED®, BREEAM®, DGNB, WELL

Intrinsic protection against back flow.

Fits: IMO, LULU, MADISON, MEM, TARA, CL.1, LISSÉ, VAIA, META, SERIES-VARIOUS, CYO

Fits MEM, CL.1, IMO, META, TARA, VAIA, LULU, LISSÉ, CYO

	Platinum	28 015 979-08
	Chrome	28 015 979-00
	Brushed Platinum	28 015 979-06
	Matte White	28 015 979-10
	Dark Chrome	28 015 979-19
	Brushed Durabronz (23kt Gold)	28 015 979-28
	Matte Black	28 015 979-33
	Brushed Champagne (22kt Gold)	28 015 979-46
	Champagne (22kt Gold)	28 015 979-47
	Brushed Chrome	28 015 979-93
	Brushed Dark Platinum	28 015 979-99

ST 050 306 7979

mm [inches]

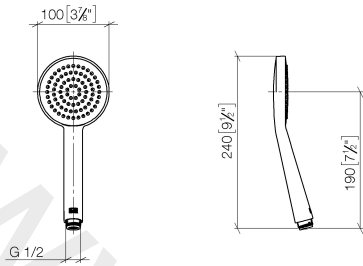

Flow rate chart

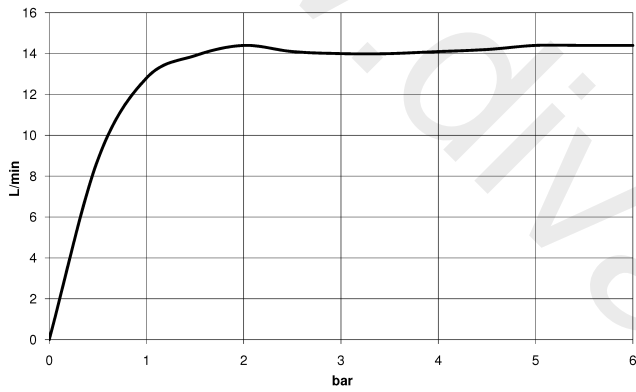

ST 050 306 7979

Parts for other
finishes can be found
here: [Chrome](#)

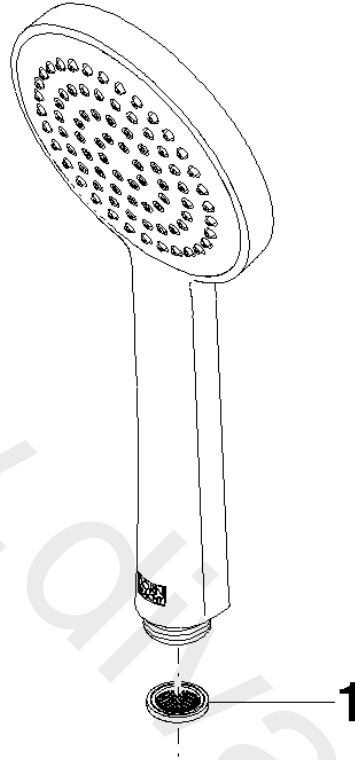

Spare parts list

No.	Item Number	Name	Quantity used	Delivery time
1	09 23 01 039 90	sieve	1	2

ST 050 306 7979



Fits: IMO, LULU, TARA, LISSÉ, VAIA, META, SERIES-VARIOUS

- shower with fixed riser projection 450 mm
- overhead shower: rain flow
- rain shower Ø 220 mm
- rain shower with anti-scale system
- max. rainshower flow 8.6 l/min
- height of fittings up to rain shower (bottom edge) 985mm
- height of fittings up to top edge of elbow 1170mm
- metal shower hose 1750mm with integrated anti-twist protection
- 1/2" connection
- slide bar
- Pipe diameter 23.5 mm
- automatic diverter for fixed-riser shower/hand shower
- quick clearing

This article does not include a hand shower!

Intrinsic protection against back flow.

Fits IMO, META, TARA, VAIA, LISSÉ, LULU

Product change as of 1.4.2023: max. flow 14 l/min

This article does not include a hand shower!

Intrinsic protection against back flow.

Fits IMO, META, TARA, VAIA, LISSÉ, LULU

Product change as of 1.4.2023: max. flow 14 l/min

	Platinum	36 112 970-08
	Chrome	36 112 970-00
	Brushed Platinum	36 112 970-06
	Dark Chrome	36 112 970-19
	Brushed Durabronze (23kt Gold)	36 112 970-28
	Matte Black	36 112 970-33
	Brushed Champagne (22kt Gold)	36 112 970-46
	Champagne (22kt Gold)	36 112 970-47
	Brushed Chrome	36 112 970-93
	Brushed Dark Platinum	36 112 970-99

Required miscellaneous



- Concealed wall mounting**
- min. recess depth 80 mm
 - max. recess depth 105 mm

35 050 970 90

Required miscellaneous



Hand shower

28 015 979-08
0010

Required miscellaneous



Hand shower

28 016 979-08

Required miscellaneous



Hand shower

28 012 979-08

Required miscellaneous



Hand shower

28 017 979-08
0010

Required miscellaneous



Hand shower

28 016 979-08
0010

Required miscellaneous



Hand shower

28 012 979-08
0010

Required miscellaneous



Hand shower

28 017 979-08

Required miscellaneous



Hand shower

28 019 979-08

Required miscellaneous



Hand shower

28 018 979-08

Required miscellaneous



Hand shower

28 018 979-08
0010

www.divapor.com

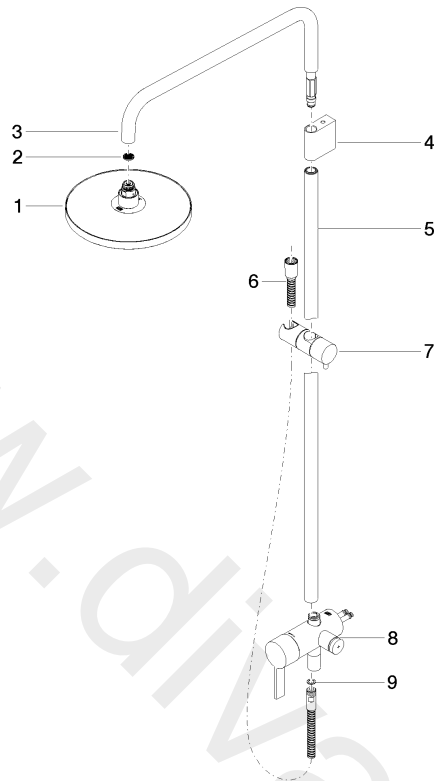

Spare parts list

No.	Item Number	Name	Quantity used	Delivery time
1	04 12 05 092 00-08	shower	1	20
2	09 23 01 039 90	sieve	1	2
3	90 28 22 348 00-08	pipe	1	20
4	90 17 11 149 00-08	holder	1	20
5	04 28 22 349 00-08	pipe	1	20
6	28 322 970-08	Metal shower hose 1/2" x 3/8" x 1750 mm	1	2
7	12 570 970-08	Slide unit	1	20
8	90 17 01 251 00-08	connection	1	20
9	09 14 20 026 90	seal	1	2