







ST 050 301 6360



- shower with fixed riser projection 420 mm
- overhead shower: rain flow
- rain shower Ø 200 mm
- max. rainshower flow 9 l/min
- hand shower: normal flow
- spray head Ø 64mm
- max. hand shower flow 9 l/min
- rotary diverter for fixed-riser shower/hand shower
- height of fittings up to top edge of elbow 1180mm
- height of fittings up to rain shower (bottom edge) 1009mm
- rosette for shower holder Ø 66mm
- rosette for wall mounting Ø 70mm
- rosette for shower mixer Ø 60mm
- gauge 150 mm - 13 mm
- metal shower hose 1250mm with integrated anti-twist protection
- 1/2" connection
- Pipe diameter 20 mm

	Platinum	ST 050 301 6360-08
	Chrome	ST 050 301 6360-00
	Brushed Platinum	ST 050 301 6360-06
	Durabrace (23kt Gold)	ST 050 301 6360-09
	Brushed Durabrace (23kt Gold)	ST 050 301 6360-28
	Brushed Dark Platinum	ST 050 301 6360-99

**Individual components of this set**

You need the following components for this set

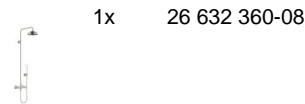
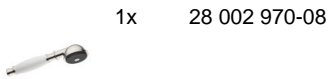

www.divapor.com

ST 050 301 6360



- normal flow
- spray head Ø 64mm
- 1/2" connection
- max. flow 9 l/min
- WRAS: 1809019
- This product can help a building to meet requirements of Green Building Rating Systems, e.g. LEED®, BREEAM®, DGNB, WELL

Intrinsic protection against back flow.

Fits MADISON

	Platinum	28 002 970-08
	Chrome	28 002 970-00
	Gold (23.9kt)	28 002 970-01
	Brushed Platinum	28 002 970-06
	Durabrand (23kt Gold)	28 002 970-09
	Brushed Durabrand (23kt Gold)	28 002 970-28
	Brushed Chrome	28 002 970-93
	Brushed Dark Platinum	28 002 970-99

www.divapor.com

ST 050 301 6360

mm [inches]

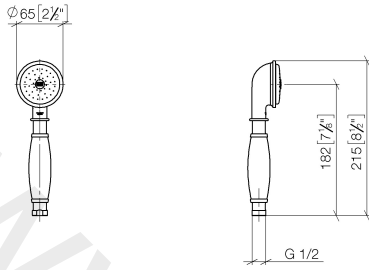

Flow rate chart

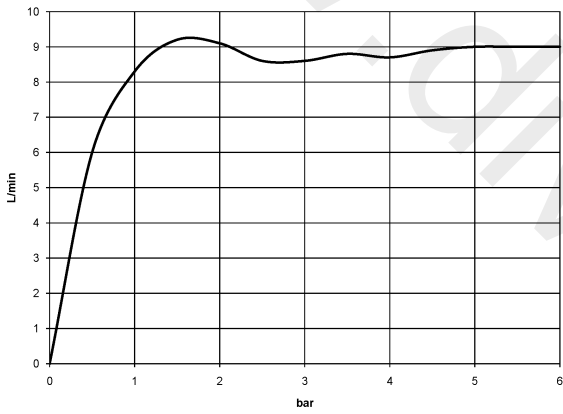

ST 050 301 6360

Parts for other finishes can be found here: [Chrome](#)

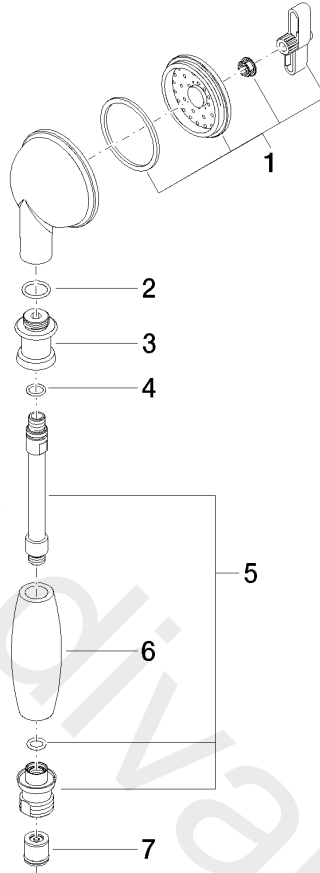

Spare parts list

No.	Item Number	Name	Quantity used	Delivery time
1	90 12 01 010 00 90	set	1	2
2	09 14 10 069 90	seal	1	2
3	09 24 04 059 20-08	nipple	1	20
4	09 14 10 042 90	seal	1	2
5	90 28 22 033 00-08	insert	1	-
6	11 167 820 60	handle	1	2
7	09 23 01 077 90	flow reducer	1	2

ST 050 301 6360



- shower with fixed riser projection 420 mm
- overhead shower: rain flow
- rain shower Ø 200 mm
- max. rainshower flow 9 l/min
- rotary diverter for fixed-riser shower/hand shower
- height of fittings up to top edge of elbow 1180mm
- height of fittings up to rain shower (bottom edge) 1009mm
- rosette for shower holder Ø 66mm
- rosette for wall mounting Ø 70mm
- rosette for shower mixer Ø 60mm
- gauge 150 mm - 13 mm
- metal shower hose 1250mm with integrated anti-twist protection
- 1/2" connection
- Pipe diameter 20 mm
- This product can help a building to meet requirements of Green Building Rating Systems, e.g. LEED®, BREEAM®, DGNB, WELL

	Platinum	26 632 360-08
	Chrome	26 632 360-00
	Brushed Platinum	26 632 360-06
	Durabrace (23kt Gold)	26 632 360-09
	Brushed Durabrace (23kt Gold)	26 632 360-28
	Brushed Dark Platinum	26 632 360-99

This article does not include a hand shower!

Fits MADISON

Intrinsic protection against back flow.

Product change as of 1.4.2023: max. flow 14 l/min

Required miscellaneous

	<b>Hand shower</b> •three settings: normal flow, soft flow, massage flow •spray head Ø 95mm •max. flow 9 l/min •Hand shower see page {PAGE}	28 002 978-08
--	---	---------------

Required miscellaneous

	<b>Metal hand shower with porcelain insert (white)</b>	28 002 970-08 0010
--	--	-----------------------

Required miscellaneous

	<b>Hand shower</b> •three settings: normal flow, soft flow, massage flow •spray head Ø 95mm •max. flow 6.8 l/min •Hand shower see page {PAGE}	28 002 978-08 0010
--	---	-----------------------

www.divapor.com

ST 050 301 6360

mm [inches]

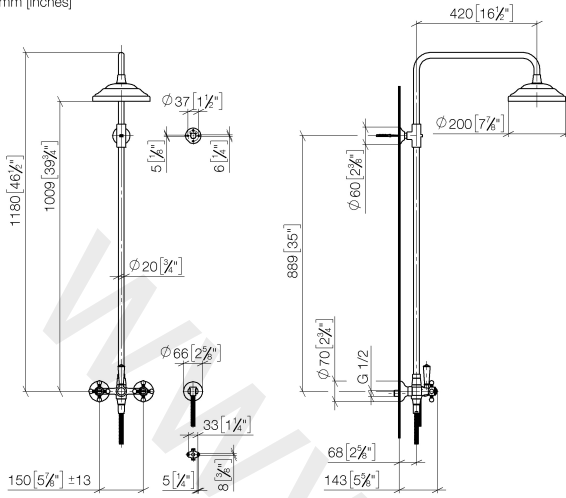

Flow rate chart

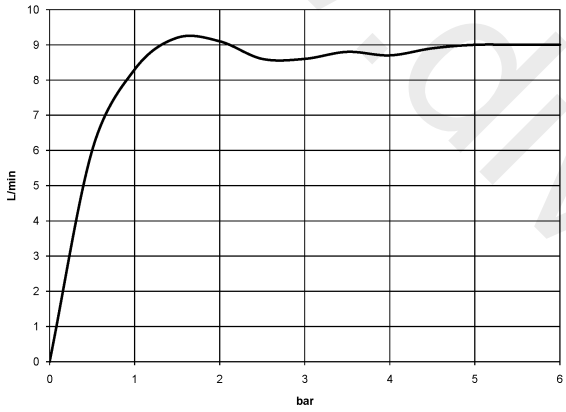

ST 050 301 6360

Parts for other finishes can be found here: [Chrome](#)

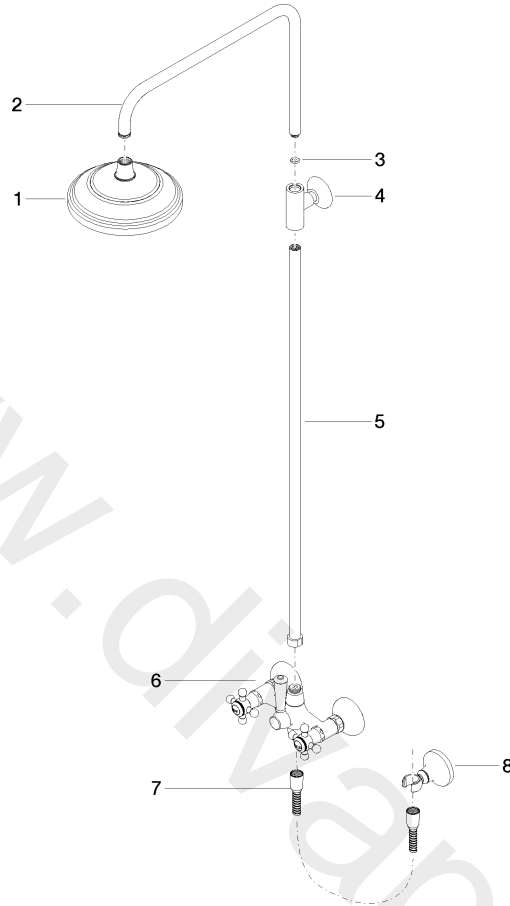

Spare parts list

No.	Item Number	Name	Quantity used	Delivery time
1	04 12 05 038 30-08	shower	1	20
2	04 28 22 101 20-08	spout	1	20
3	09 14 10 011 90	seal	1	2
4	90 17 11 033 00-08	holder	1	-
5	90 28 22 096 00-08	pipe	1	-
6	04 17 10 001 00-08	fitting	1	20
7	28 104 970-08	Metal shower hose 1/2" x 1/2" x 1250 mm	1	2
8	28 050 410-08	holder	1	60