







ST 060 112 0360



- cover plate Ø 124 mm
 - rosette Ø 55 mm
 - temperature control handle with safety limit stop at 38°C
 - thermostat cartridge
 - 2x head part with cut-to-length spindle and sleeve
- Fits MADISON**

	Platinum	ST 060 112 0360-08
	Chrome	ST 060 112 0360-00
	Brushed Platinum	ST 060 112 0360-06
	Durabronze (23kt Gold)	ST 060 112 0360-09
	Brushed Durabronze (23kt Gold)	ST 060 112 0360-28
	Brushed Dark Platinum	ST 060 112 0360-99

Individual components of this set

You need the following components for this set

	1x	36 503 977-08		2x	36 607 361-08
---	----	---------------	---	----	---------------







www.divapor.com

ST 060 112 0360



- cover plate Ø 124 mm
- temperature control handle with safety limit stop at 38°C
- thermostat cartridge

Codes & standards

	Platinum	36 503 977-08
	Chrome	36 503 977-00
	Brushed Platinum	36 503 977-06
	Durabass (23kt Gold)	36 503 977-09
	Brushed Durabass (23kt Gold)	36 503 977-28
	Brushed Dark Platinum	36 503 977-99

Required miscellaneous



xTOOL Concealed thermostat module without volume control 35 503 970 90
 •min. recess depth 85 mm
 •max. recess depth 110 mm

Recommended miscellaneous



xGRID Attachment set for integrating in the dry wall construction 12 340 970 90

Required miscellaneous



xGRID Installation track 555 mm 12 360 970 90

ST 060 112 0360

mm [inches]

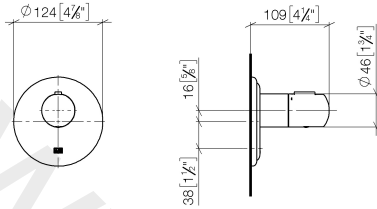

www.divapor.com

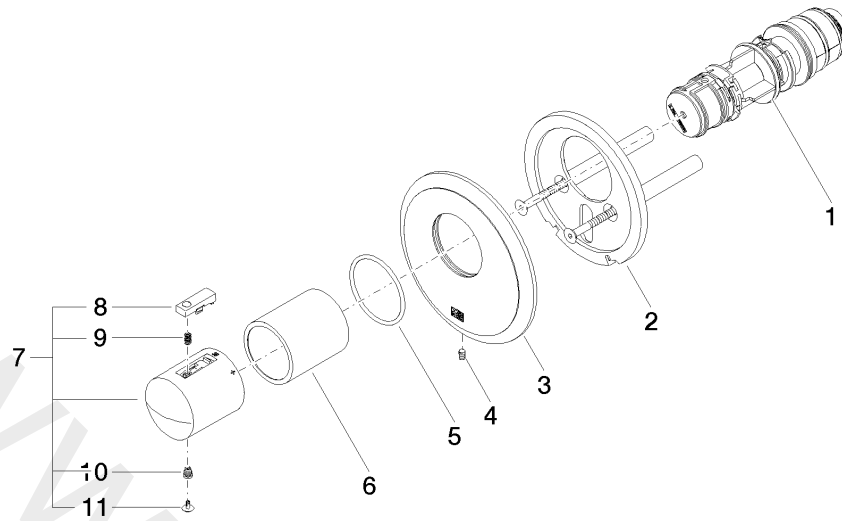

Spare parts list

No.	Item Number	Name	Quantity used	Delivery time
1	90 15 02 065 00 90	cartridge	1	2
2	90 11 01 196 00 90	base	1	2
3	09 11 02 543-08	cover	1	60
4	09 31 11 048 90	pin	1	2
5	09 14 10 049 90	seal	1	2
6	09 21 02 112-08	sleeve	1	20
7	04 17 33 005 01-08	handle	1	20
8	90 21 33 010 00-13	handle	1	2
9	90 16 02 027 00 90	spring	1	2
10	09 30 30 136 90	screw	1	2
11	09 31 20 049-13	plug	1	30

ST 060 112 0360









- rosette Ø 55 mm
- head part with cut-to-length spindle and sleeve
- 3x porcelain insert: HOT, COLD and NEUTRAL

Codes & standards

Fits MADISON

Fits MADISON

	Platinum	36 607 361-08
	Chrome	36 607 361-00
	Brushed Platinum	36 607 361-06
	Durabrace (23kt Gold)	36 607 361-09
	Brushed Durabrace (23kt Gold)	36 607 361-28
	Brushed Dark Platinum	36 607 361-99

Required miscellaneous



Wall valve 1/2"

35 607 970 90

- min. recess depth 75 mm
- max. recess depth 145 mm

www.divapor.com

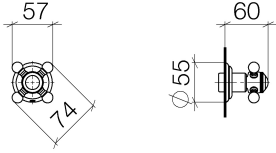

www.divapor.com

ST 060 112 0360

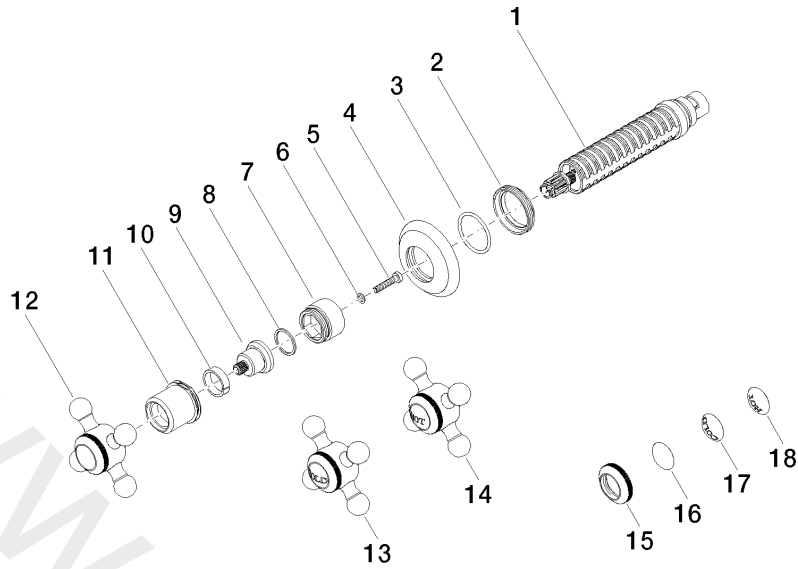

Spare parts list

No.	Item Number	Name	Quantity used	Delivery time
1	90 90 03 143 00 90	top	1	2
2	09 23 10 125-00	nut	1	10
3	09 14 10 063 90	seal	1	2
4	09 27 36 102-08	rosette	1	20
5	09 30 30 075 90	screw	1	2
6	09 30 11 194 90	disc	1	2
7	09 18 30 007-08	sleeve	1	60
8	09 28 10 030 90	ring	1	2
9	09 12 12 064-08	base	1	60
10	09 14 15 021 90	ring	1	2
11	09 21 02 161-08	cover	1	20
12	04 20 36 100 02-08	handle	1	20
13	04 20 36 100 00-08	handle (cold)	1	20
14	04 20 36 100 01-08	handle (hot)	1	20
15	09 20 36 005-08	handle	1	20
16	09 26 01 016 90	accessories	1	2
17	09 26 01 010 90	accessories	1	2
18	09 26 01 011 90	accessories	1	2