







ST 050 304 6360



- shower with fixed riser projection 420 mm
- rain shower Ø 200 mm
- rain shower with anti-scale system
- max. rainshower flow 9 l/min
- hand shower: three settings: normal flow, soft flow, massage flow
- spray head Ø 95mm
- max. hand shower flow 9 l/min
- rotary diverter for fixed-riser shower/hand shower
- height of fittings up to rain shower (bottom edge) 985mm
- height of fittings up to top edge of elbow 1160mm
- two-part push-on rosette Ø 65 mm
- rosette for shower holder Ø 65mm
- rosette for wall mounting Ø 60mm
- gauge 150 mm - 13 mm
- metal shower hose 1250mm with integrated anti-twist protection
- 1/2" connection
- Pipe diameter 20 mm

	Brushed Platinum	ST 050 304 6360-06
	Chrome	ST 050 304 6360-00
	Platinum	ST 050 304 6360-08
	Durabrace (23kt Gold)	ST 050 304 6360-09
	Brushed Durabrace (23kt Gold)	ST 050 304 6360-28
	Brushed Dark Platinum	ST 050 304 6360-99

Individual components of this set







You need the following components for this set

	1x	11 420 360-06		1x	28 002 978-06
	1x	34 459 360-06			

www.divapor.com

ST 050 304 6360



	Brushed Platinum	11 420 360-06
	Chrome	11 420 360-00
	Platinum	11 420 360-08
	Durabress (23kt Gold)	11 420 360-09
	Brushed Durabress (23kt Gold)	11 420 360-28
	Brushed Dark Platinum	11 420 360-99

www.divapor.com

www.divapor.com

www.divapor.com

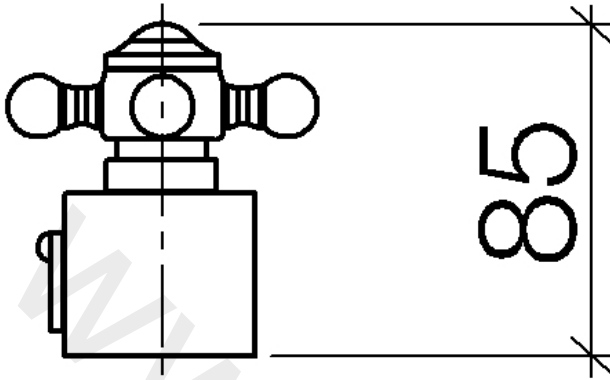

www.divapor.com

ST 050 304 6360

Parts for other finishes can be found here: [Chrome](#)

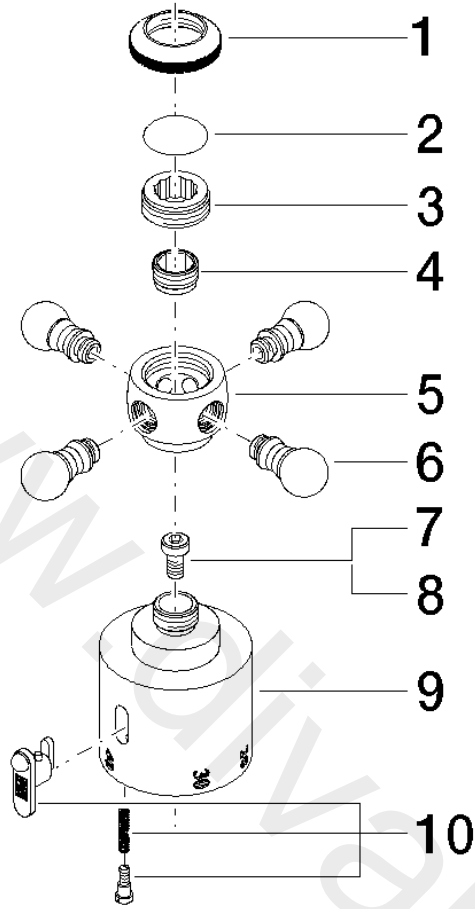

Spare parts list

No.	Item Number	Name	Quantity used	Delivery time
1	09 20 36 005-06	handle	1	10
2	09 26 01 016 90	accessories	1	2
3	09 20 83 006 90	handle	1	2
4	09 24 03 119 90	nipple	1	2
6	09 20 36 004-06	handle	4	10
7	09 30 30 027 90	screw	1	2
8	09 30 33 004 90	screw	1	2
10	90 21 33 020 00 90	handle	1	2







ST 050 304 6360



- three settings: normal flow, soft flow, massage flow
- with anti-scale system
- spray head Ø 95mm
- 1/2" connection
- max. flow 9 l/min

Intrinsic protection against back flow.

Fits MADISON

	Brushed Platinum	28 002 978-06
	Chrome	28 002 978-00
	Platinum	28 002 978-08
	Durabress (23kt Gold)	28 002 978-09
	Brushed Durabress (23kt Gold)	28 002 978-28
	Brushed Chrome	28 002 978-93
	Brushed Dark Platinum	28 002 978-99

www.divapor.com

www.divapor.com

ST 050 304 6360

mm [inches]

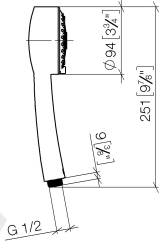

Flow rate chart

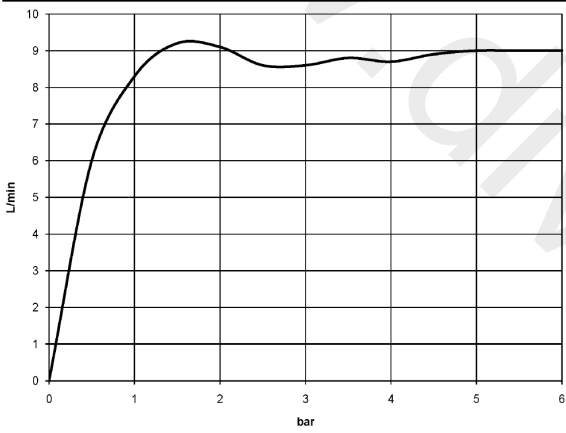

ST 050 304 6360

Parts for other
finishes can be found
here: [Chrome](#)

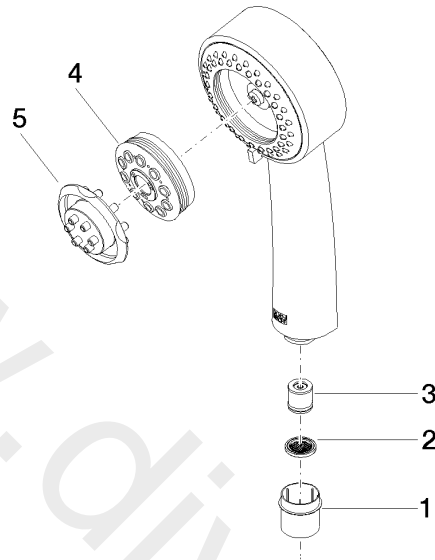

Spare parts list

No.	Item Number	Name	Quantity used	Delivery time
1	09 21 02 115 90	cap	1	2
2	09 23 01 039 90	sieve	1	2
3	09 23 01 077 90	flow reducer	1	2
4	04 12 11 071 00 90	shower	1	2
5	09 30 09 022 90	key	1	2

ST 050 304 6360



- shower with fixed riser projection 420 mm
- rain shower Ø 200 mm
- rain shower with anti-scale system
- max. rainshower flow 9 l/min
- rotary diverter for fixed-riser shower/hand shower
- height of fittings up to rain shower (bottom edge) 985mm
- height of fittings up to top edge of elbow 1160mm
- two-part push-on rosette Ø 65 mm
- rosette for shower holder Ø 65mm
- rosette for wall mounting Ø 60mm
- gauge 150 mm - 13 mm
- metal shower hose 1250mm with integrated anti-twist protection
- 1/2" connection
- Pipe diameter 20 mm
- This product can help a building to meet requirements of Green Building Rating Systems, e.g. LEED®, BREEAM®, DGNB, WELL







This article does not include a hand shower!

Fits MADISON

Intrinsic protection against back flow.

NOTE: The handles must be ordered separately from the fittings!

Product change as of 1.4.2023: max. flow 14 l/min

	Brushed Platinum	34 459 360-06
	Chrome	34 459 360-00
	Platinum	34 459 360-08
	Durabrand (23kt Gold)	34 459 360-09
	Brushed Durabrand (23kt Gold)	34 459 360-28
	Brushed Dark Platinum	34 459 360-99

www.divapor.com

ST 050 304 6360

1:10

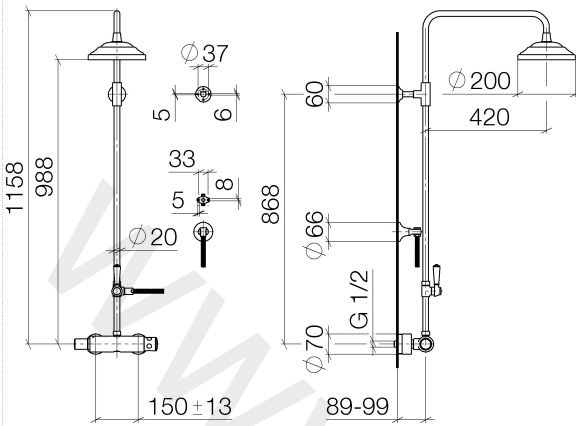

Flow rate chart

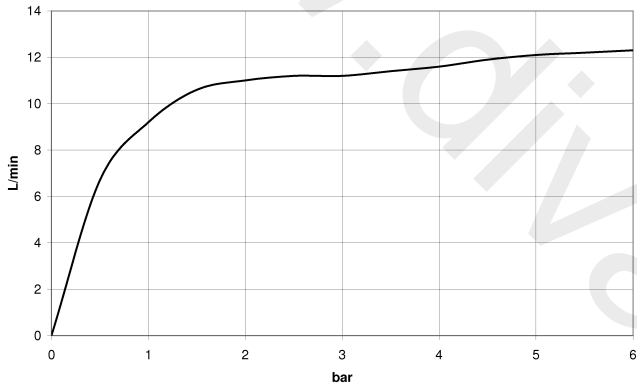

ST 050 304 6360

Parts for other finishes can be found here: [Chrome](#)

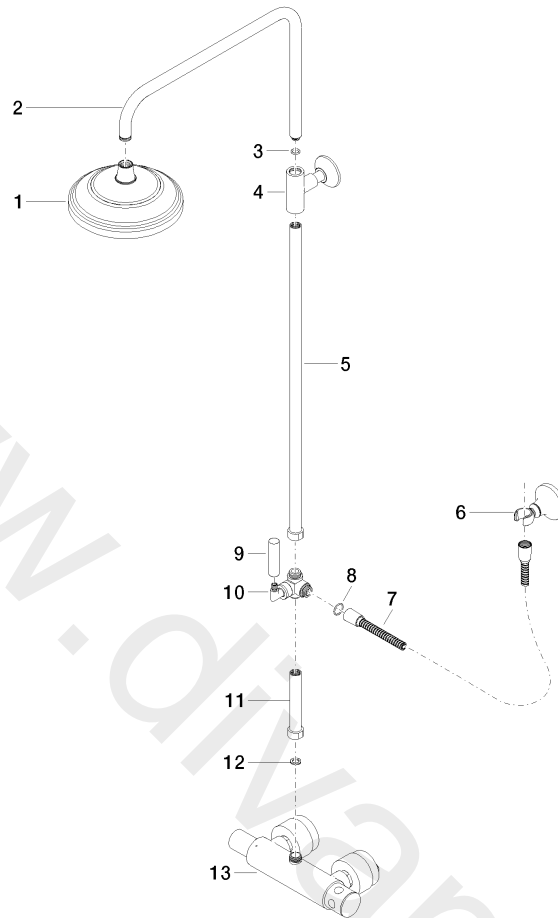

Spare parts list

No.	Item Number	Name	Quantity used	Delivery time
1	04 12 05 038 01-06	shower	1	60
2	04 28 22 101 20-06	spout	1	10
3	09 14 10 011 90	seal	1	2
4	90 17 11 037 01-06	holder	1	-
5	90 28 22 104 00-06	pipe	1	-
6	90 17 09 045 01-06	diverter	1	10
7	09 30 30 064-06	screw	1	10
8	09 18 20 011-06	base	1	10
9	09 28 22 013 90	pipe	1	2
10	11 170 370-06	Lever insert	1	10
11	09 30 30 062-06	screw	1	10
12	09 14 10 122 90	seal	1	2
13	28 104 970-06	Metal shower hose 1/2" x 1/2" x 1250 mm	1	2
14	28 050 410-06	holder	1	60
15	90 28 22 103 00-06	pipe	1	-
16	09 14 20 002 90	seal	1	2
17	04 17 01 044 01-06	fitting	1	10