







27 523 811



- 167 mm projection
- rectangular, air-enriched flow
- height of mixer 198 mm
- height up to aerator 133 mm
- complete hand shower set: normal flow
- complete hand shower set with anti-scale system
- hole diameter spout 32 mm
- hole diameter valve 32 mm
- rosette for complete hand shower set 60 x 60mm
- handle Ø 60mm
- metal shower hose 1750mm with integrated anti-twist protection
- max. flow 23.8 l/min at 3 bar flow pressure
- max. flow for complete hand shower set 6.8 l/min

NOTE: The handle inserts must be ordered separately from the fittings!

	Brushed Platinum	27 523 811-06
	Chrome	27 523 811-00
	Dark Chrome	27 523 811-19
	Brushed Durabronze (23kt Gold)	27 523 811-28
	Brushed Champagne (22kt Gold)	27 523 811-46
	Champagne (22kt Gold)	27 523 811-47
	Brushed Dark Platinum	27 523 811-99

27 523 811

Parts for other finishes can be found here: [Chrome](#)

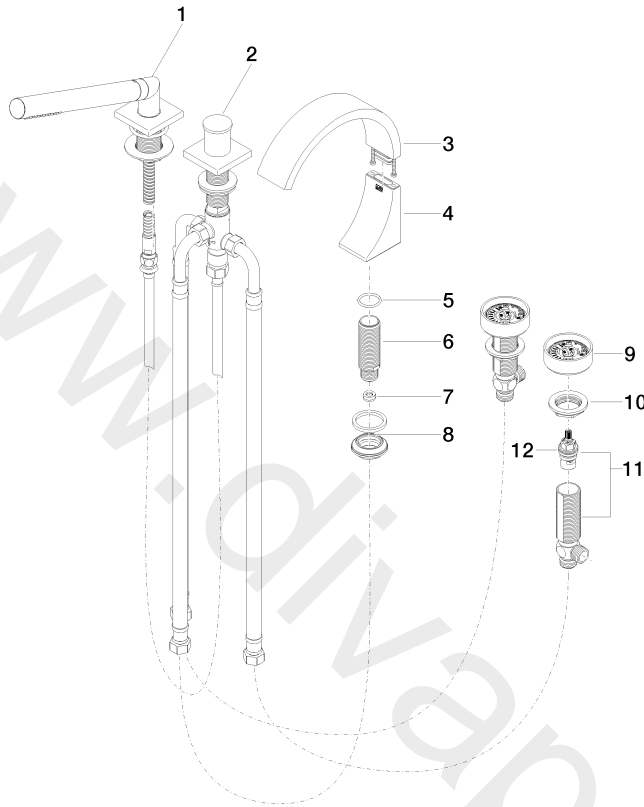

Spare parts list

No.	Item Number	Name	Quantity used	Delivery time
1	27 702 980-06	Hand shower set for bath rim or tile edge installation	1	10
2	29 140 670-06	Two-way diverter for bath rim or tile edge installation	1	10
3	90 11 70 013 00-06	spout	1	10
4	90 19 70 011 00-06	connection	1	10
5	09 14 10 009 90	seal	1	2
6	09 30 01 117 90	connection	1	2
7	09 23 01 057 90	flow reducer	1	2
8	04 23 10 044 09 90	fixing set	1	2
9	90 18 40 291 01-06	handle	2	10
10	04 30 11 038 68 90	fixing set	1	2
11	04 17 11 055 41 90	side panel	2	2
12	90 90 03 239 00 90	top	2	2