

Ordering spares / Ersatzteil - Regelung / Pièces de rechange / Parti di ricambio / Lista de recambios / Onderdelen bestellen (NL/B) / Κωδικοί Ανταλλακτικών / Bestilling af reservedele / Beställning av reservdelar / Bestilling av reservedeler / Резервни части / Запчасти / Części zapasowe / Piese de schimb / Rendelhető alkatrészek / Запасні частини / Резервни делови / Резервни делови / Atsarginių dalių / Tellitavad varuosad / Rezerves daļas / Náhradní díly / Náhradné diely / Yedek parça siparişi / Nadomestni deli

XX = AA, AD, .....

1 - B 961654 XX	20 - B 961233 NU
3 - B 960473 XX	23 - A 963489 XX
4 - B 961386 XX	28 - B 961346 NU
5 - B 961387 NU	29 - A 961640 NU
6 - A 861181 NU	30 - B 964675 XX
7 - A 861156 NU	29 - A 960944 NU
11 - B 960645 NU	30 - B 960604 XX
12 - B 960646 XX	31 - B 960486 XX
13 - A 960537 XX	32 - B 960167 XX
14 - B 961283 XX	33 - A 960944 NU
16 - B 960583 NU	34 - B 960604 XX
18 - B 961326 NU	35 - B 9467 XX
19 - B 961389 XX	

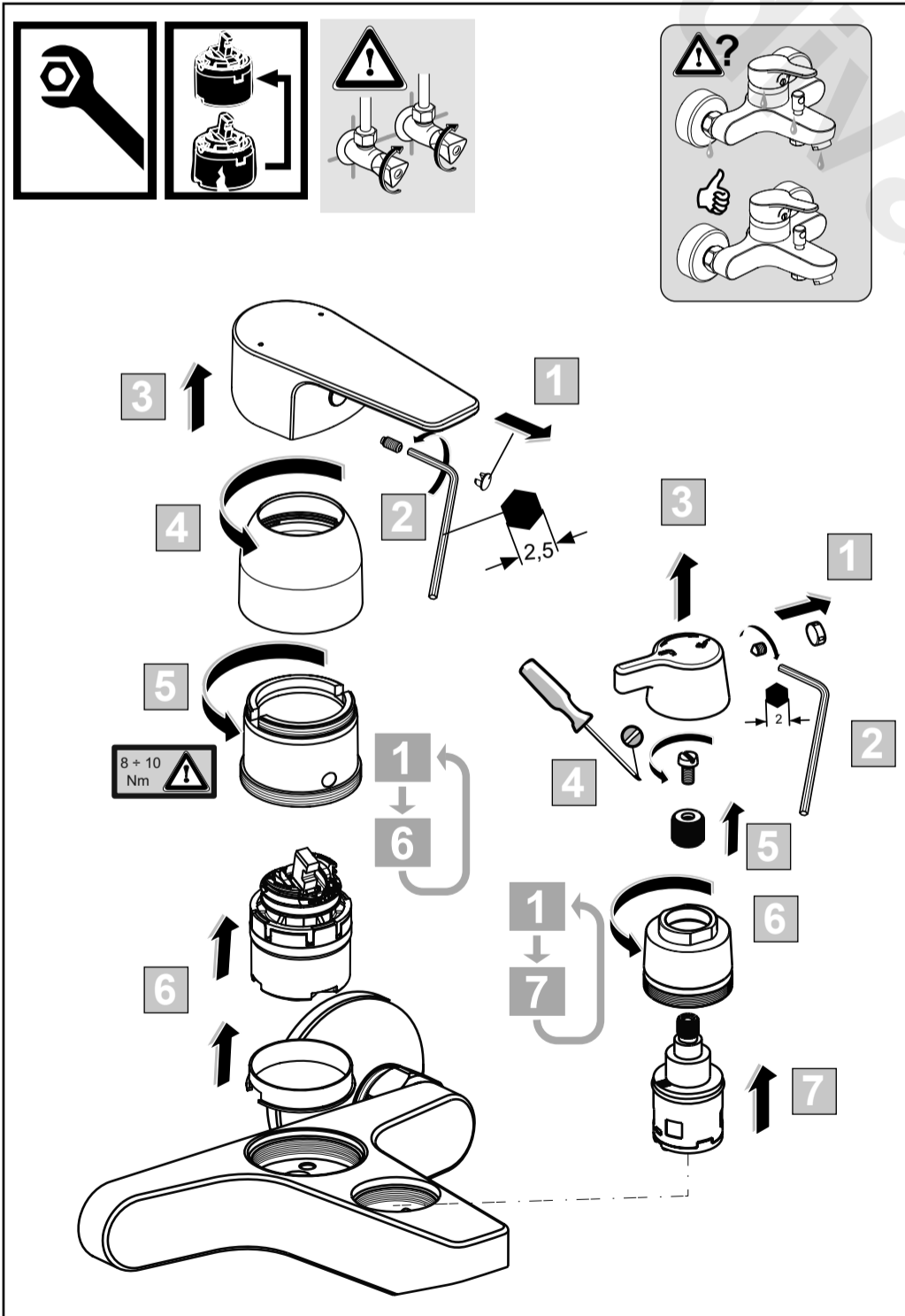
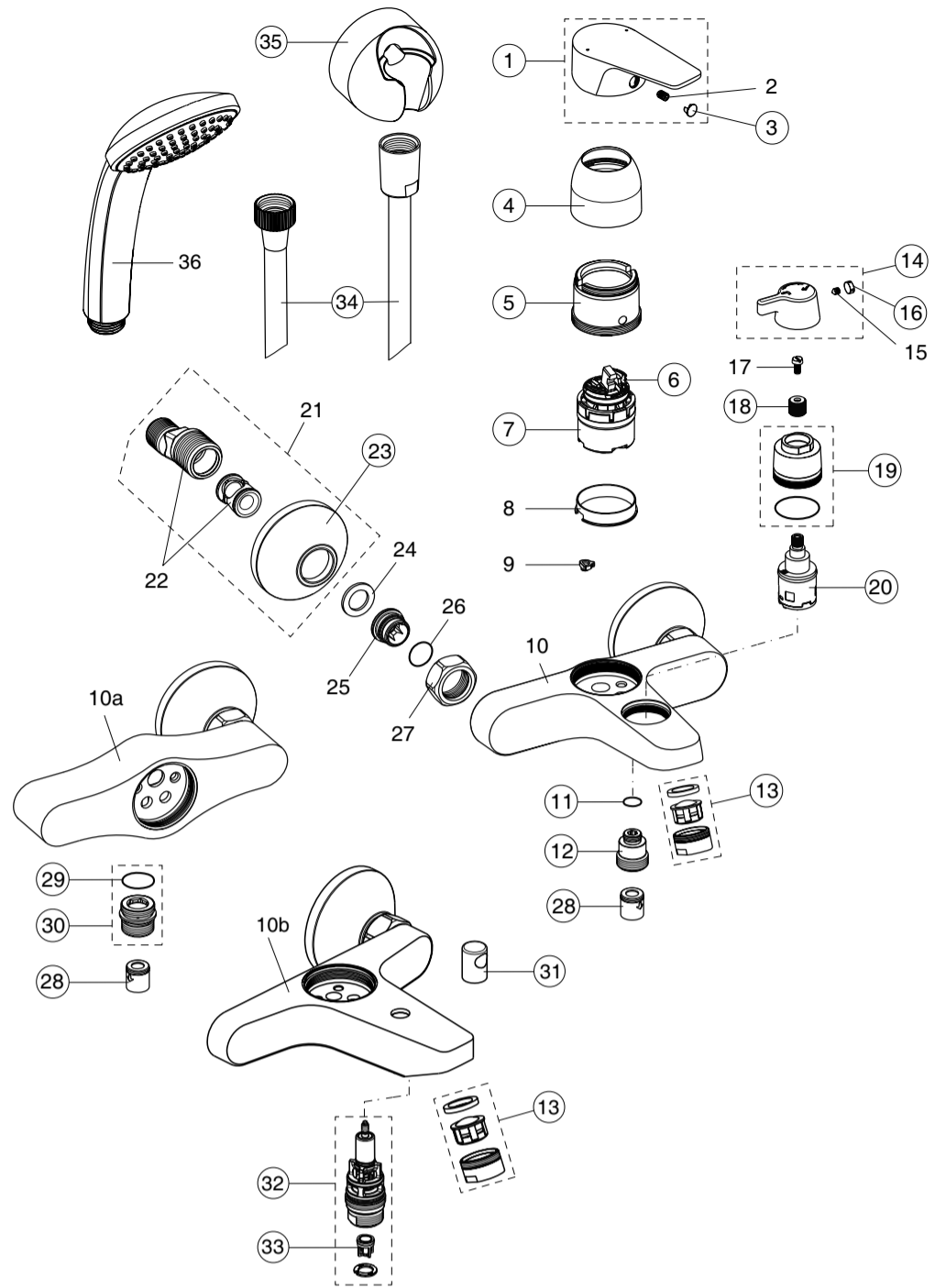

Ideal Standard

## CERAFINE MODEL D

12.2019 / B665909

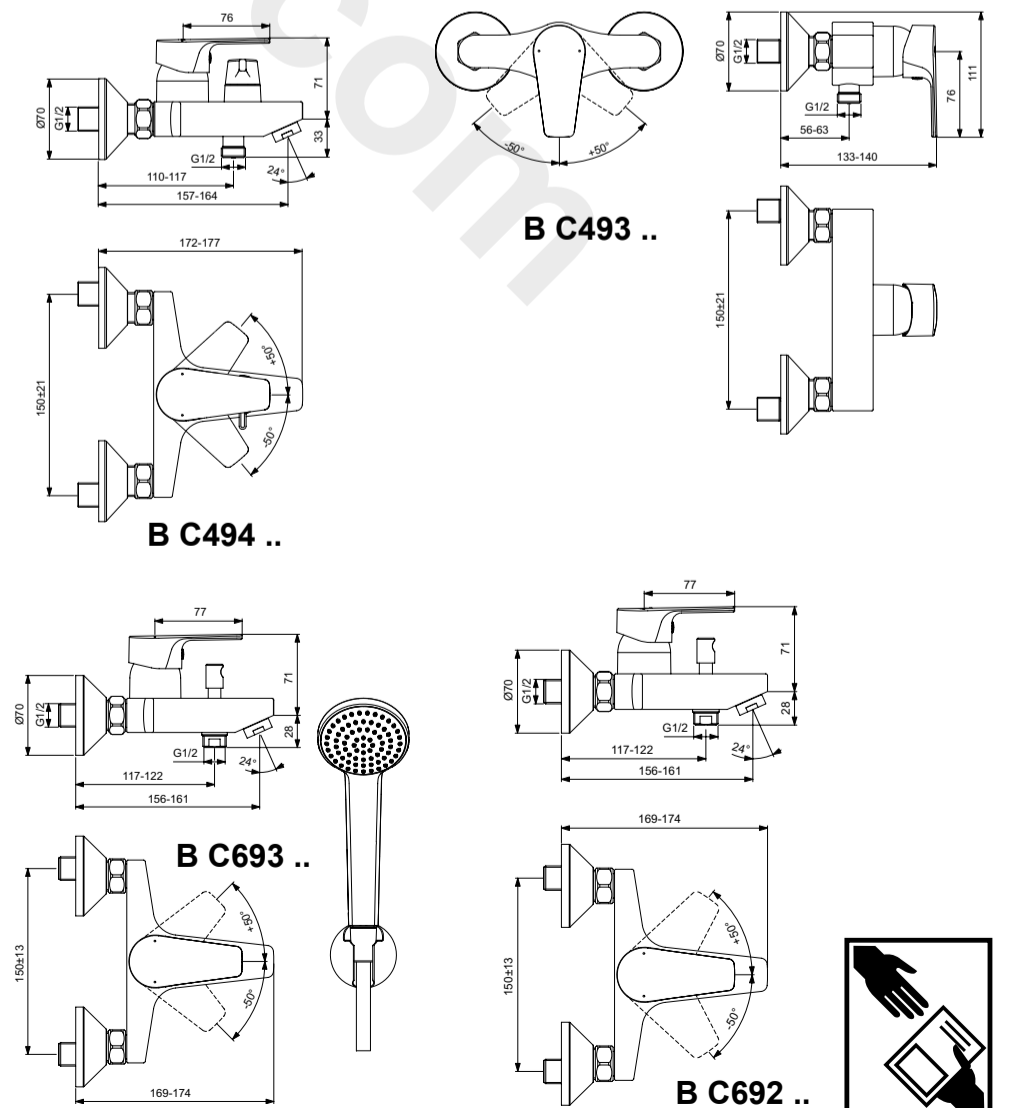

Ideal Standard International NV  
Corporate Village – Gent Building  
Da Vincilaan 2  
1935 Zaventem  
Belgium  
<http://www.idealstandardinternational.com>

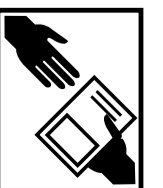

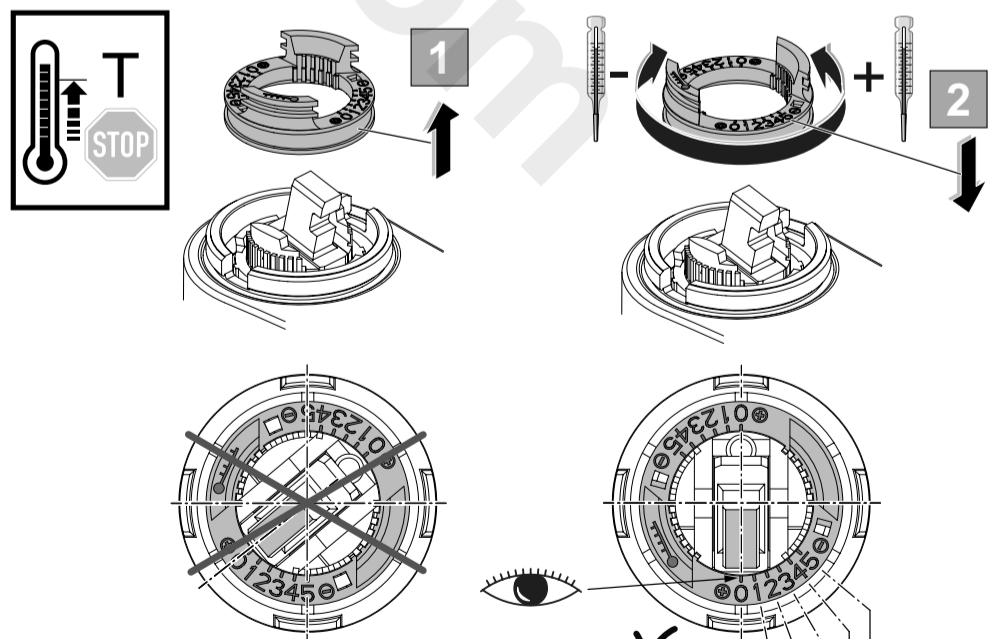
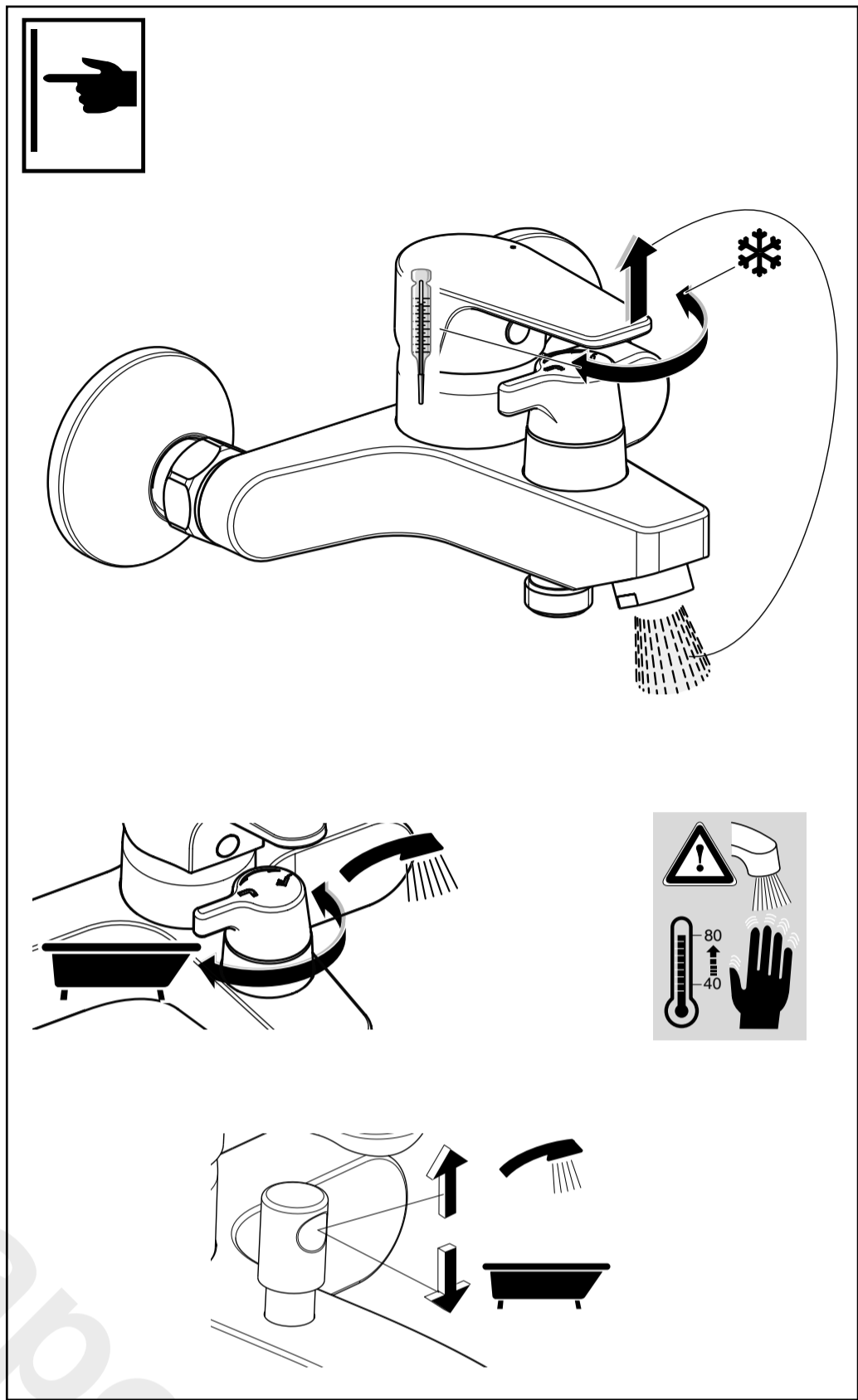
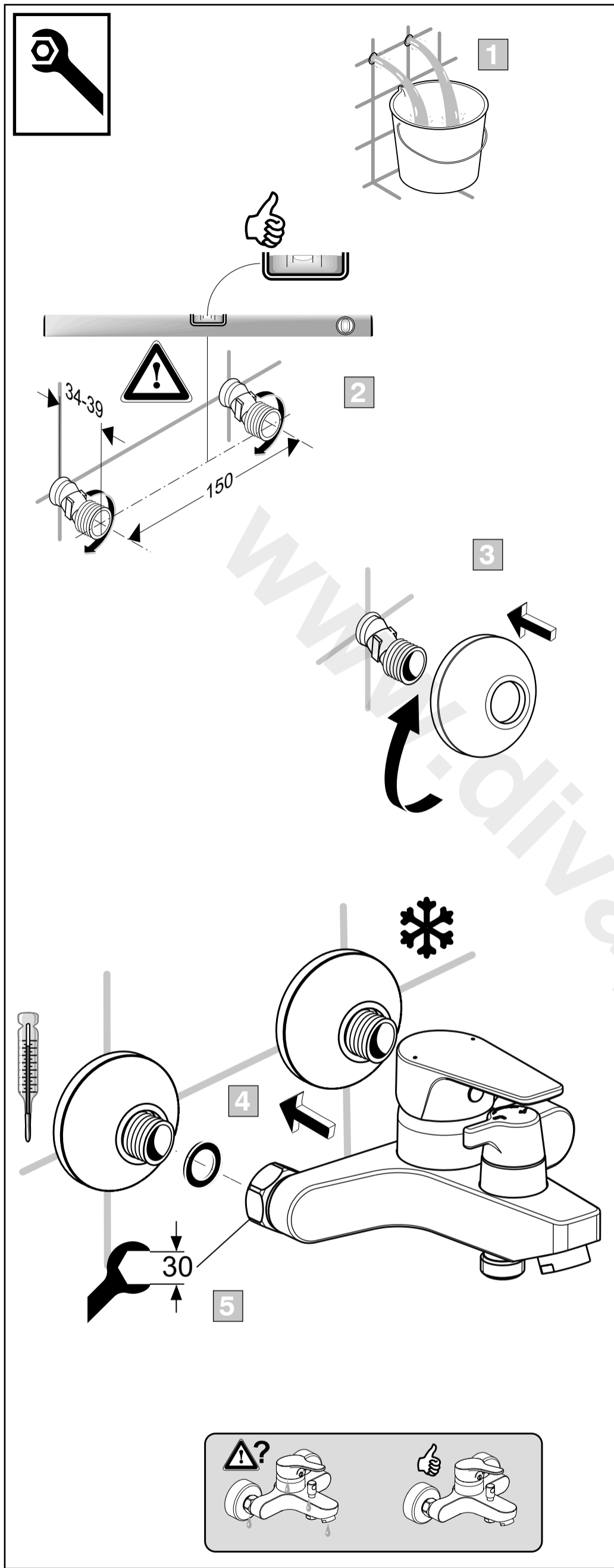

P bar	0,5	MAX. 10	1		(3 bar)
T °C		MAX. 80	65		
			40		I/min 20    13

P			0	1	2	3	4	5
			°C	°C	°C	°C	°C	°C
50°C	15°C		50	49	44	40	35	33
65°C	15°C		65	63	57	50	44	40
85°C	15°C		85	83	74	64	56	50