

CERAPLUS 2

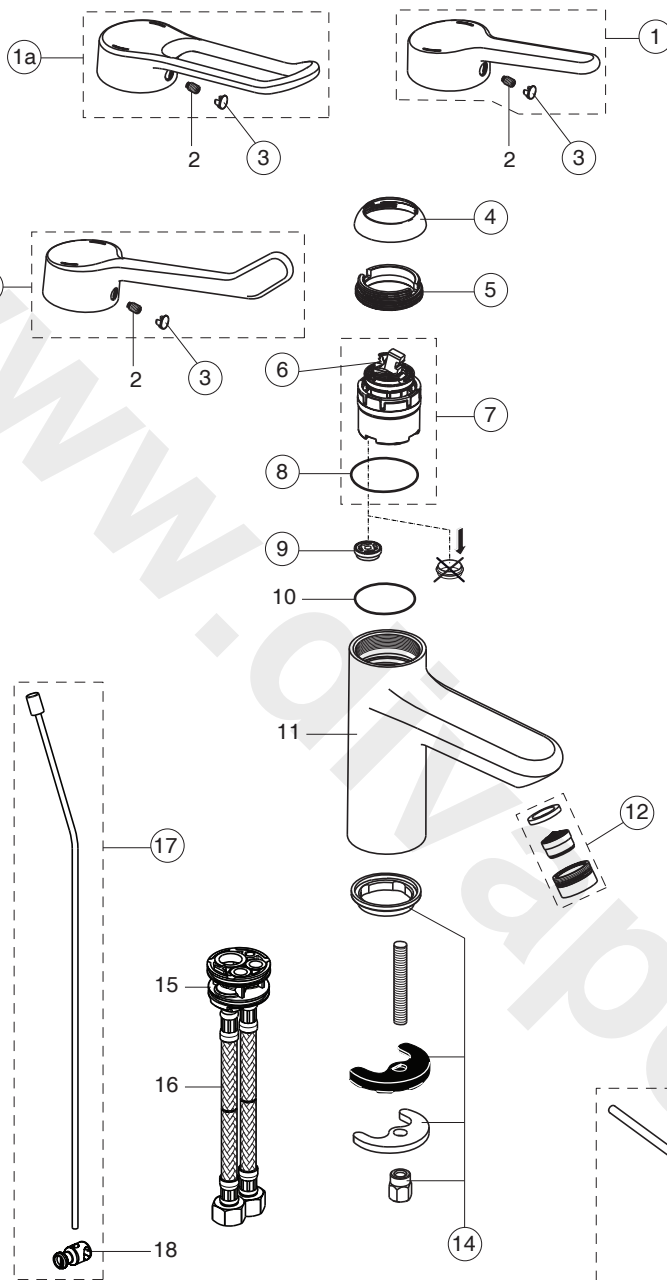

BC097AA

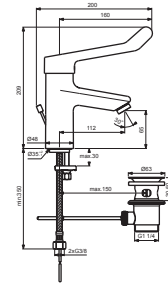

BC091AA

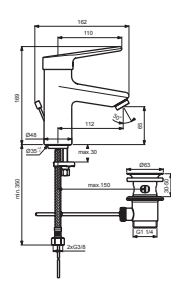

BC098AA

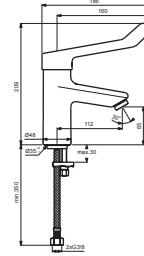

BC092AA

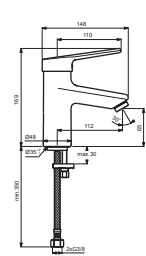

BC095AA

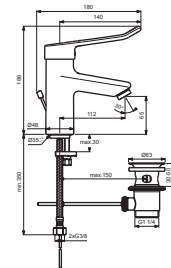

BC096AA

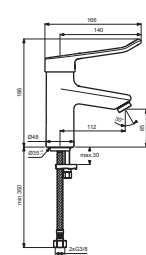

Pos.	Signify	Spare parts-Nr.	Quantity	Pos.	Signify	Spare parts-Nr.	Quantity
1	Lever,w/logo-set	B961435AA	1 Pcs.	13	Pop-up drain ass.	A962991AA	1 Pcs.
1a	Lever,w/logo-loop	B961436AA	1 Pcs.	14	Connecting set	A964520NU	1 Set
1b	Lever,w/logo-medical	B961437AA	1 Pcs.	15	Manifold		1 Pcs.
2	Screw M5x8		1 Pcs.	16	Flex pexhose G3/8-Ø10.5/L445		2 Pcs.
3	Cap decorative	B960473AA	1 Pcs.	17	Pop up waste-compl.	B961384AA	1 Pcs.
4	Cap M38x1.5	B961438AA	1 Pcs.	18	Pop up waste shackle		1 Pcs.
5	Screw M41x1.5/M38x1.5	B961374NU	1 Pcs.				
6	Hot limit stop	A861181NU	1 Pcs.				
7	Cartridge Ø38mm	A861156NU*	1 Set				
8	O-Ring Ø38x2.5	E960059NU*	1 Set				
9	Flow limiter 8.4 l/min	A962966NU	1 Pcs.				
10	O-Ring Ø34x2		1 Pcs.				
11	Body basin		1 Pcs.				
12	Fl.liner vandal proof M24x1	B960587AA	1 Pcs.				

*Universal set (not all parts needed)