

*Armitage
Shanks*

AVON 21

INSTALLATION

B8267AA Self closing basin pillar taps – push button

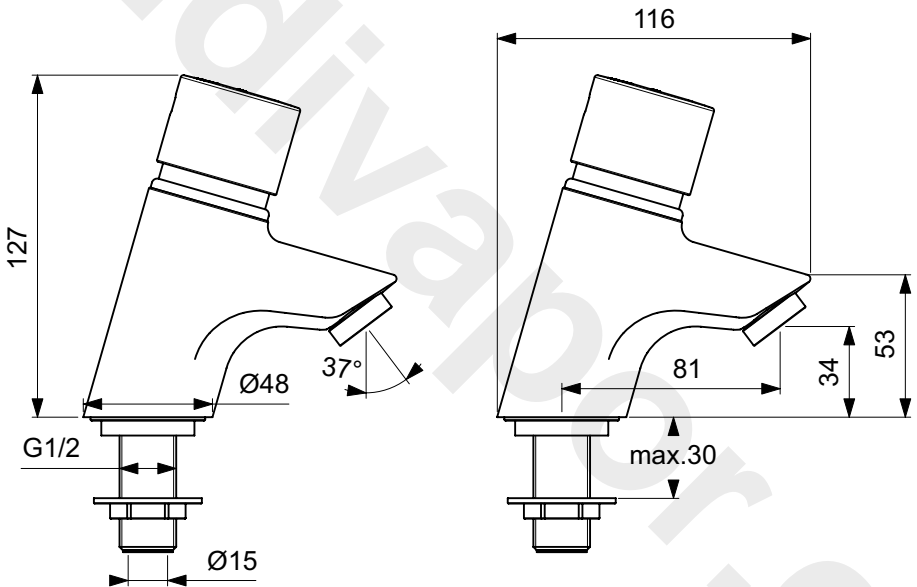

IMPORTANT
BEFORE CONNECTION, FLUSH WATER THROUGH PIPEWORK TO REMOVE ALL DEBRIS ETC. WHICH COULD DAMAGE THE VALVE MECHANISM

INSTALLER: After installation please pass this instruction booklet to user

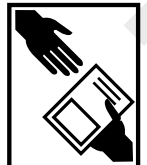

Contents

1	Product box contents	3
2	Supply conditions	4
3	Water regulations	4
4	Installation guide	5
5	Tap operation	6
6	Outlet options	6
7	Run time adjustment	7
8	Maintenance (clearing pilot hole)	8
9	Cartridge replacement	9
10	Spare parts	10
11	Cleaning chrome surfaces	11



Avon 21 Self closing basin pillar taps

These Avon 21 products are self closing taps designed for water economy. The product is fitted with a simple press down handle for easy actuation. The run-time until automatic shut off is adjustable. These products are fitted with anti-vandal outlets.

1. Product box contents



2x Red index pins



2x Blue index pins

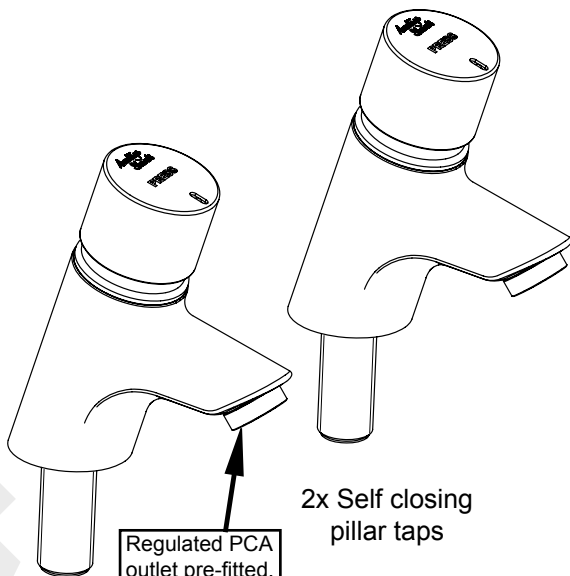

Regulated PCA outlet pre-fitted. See section 6.

2x Self closing pillar taps



2x G1/2" Back-nuts

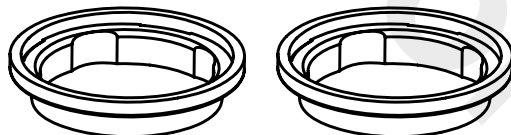

2x G1/2" basin seal mouldings



1x outlet key

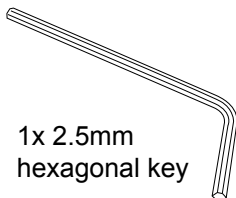

1x 2.5mm hexagonal key

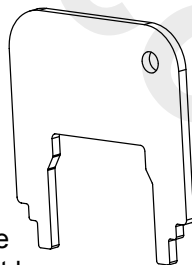

1x run time adjustment key

2. Supply conditions

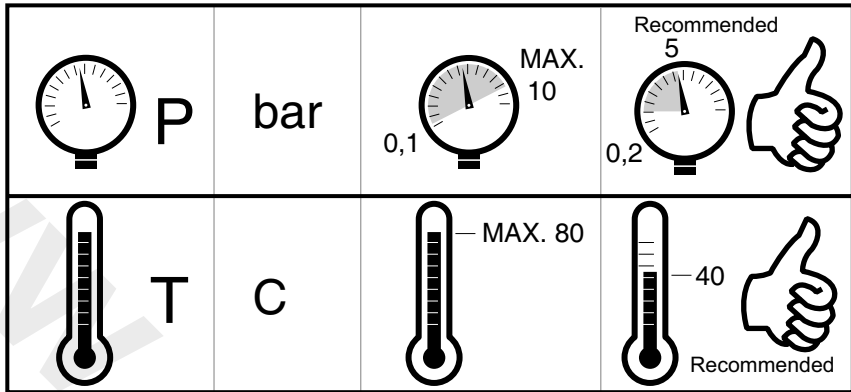

Supply temperatures:

Avoid supplying scalding water to the HOT inlet. Hot water temperature supply should be controlled to circa 40°C.

In order to maintain water quality, the hot supply should be stored & distributed at a temperature greater than 55°C.

Use of an appropriate temperature reduction device (i.e. tee pattern thermostat) is recommended to ensure delivery of safe hot water temperatures from the mixer.

Supply pressures:

The recommended working pressure for self closing taps is 0.2 to 5.0 bar.

Exceeding this pressure will adversely affect the operation of the taps.

This adverse affect can be overcome by using PRV to reduce the pressure accordingly.

3. Water regulations

The fittings covered by this installation and maintenance instruction should be installed in accordance with the water regulations published in 1999*, therefore Armitage Shanks would strongly recommend that these fittings are installed by a professional installer

* A guide to the water Supply (Water Fittings Regulations 1999 and the Water Byelaws 2000, Scotland is published by WRAS (Water Regulations Advisory Scheme) Fern Close, Pen-y-Fan Industrial Estate, Oakdale, Newport, NP11 3EH. ISBN 0-9539708-0-9

4. Installation guide



Red & Blue index pins are supplied in a bag. The appropriate coloured pin should be pressed in to each handle.

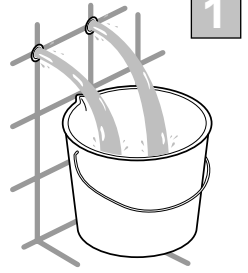
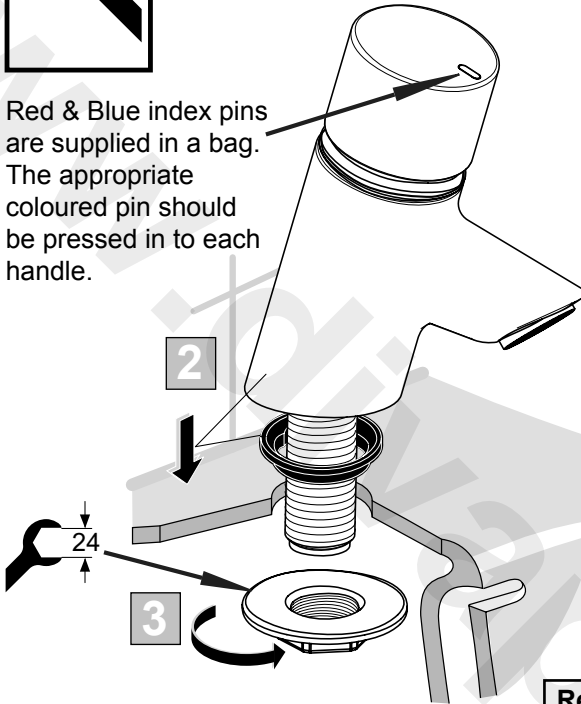

1. Before connection, flush water through pipe-work to remove all debris etc. to prevent damage to the valve mechanism.

2. Offer tap tails into basin holes, ensuring seals are in place & orientated as shown. HOT tap should be fitted on left hand side of basin (viewed from front).

3. Hand tighten the back-nut, ensure the tap spout is positioned correctly, and then tighten the back-nut securely with a tap wrench (24mm A/F).

Remember to fit isolating valves*.

RESTORE SUPPLIES & CHECK ALL JOINTS FOR LEAKS

*Isolation valves should be fitted to permit future maintenance of this product. The cartridge mechanism includes a strainer.



DO NOT apply heat near this product. Heat generated by soldering could damage plastic parts and seals.

5. Tap operation

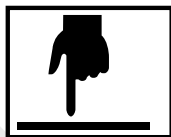



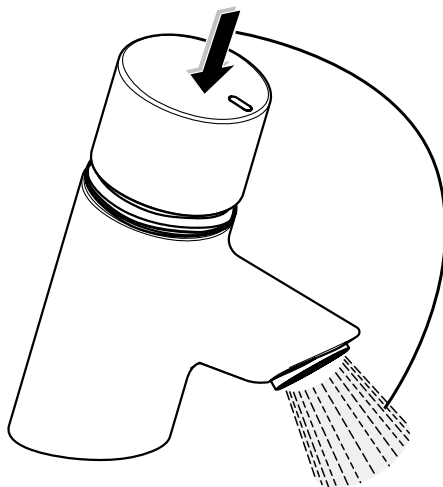

To operate this product, simply press the handle downwards & then release. Water will flow for the pre-set time (adjustable in seconds) & then the tap will self close.



6. Outlet options



The product is factory fitted with a PCA regulated outlet which is secured with an anti-vandal (AV) housing.

Flow straightener Laminar Flow (SOLD SEPARATELY)	P 3,0bar		Q 11 L/min	
Regulated PCA outlet (FACTORY FITTED)	P 3,0bar		Q 3.7 L/min	

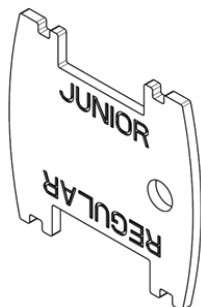

To change the outlet, use the outlet key supplied with the product to unscrew the AV housing. Using the side of the key marked "junior" locate the key into the inner ring of the housing and unscrew. Change the outlet & re-secure the housing with the key, ensuring the seal is in place.

7. Run time adjustment



This is a water saving product & is supplied set with a short run time. A run time of typically 5 to 20 seconds will suit most applications.

The run time can be adjusted as detailed below; first the handle must be removed.

1 & 2 Handle removal

To remove the handle prise out the small grommet located at the rear of the handle. Insert the 2.5mm hexagon key (supplied) into the hole & undo the grub screw a few turns. The handle should lift off from the tap body.

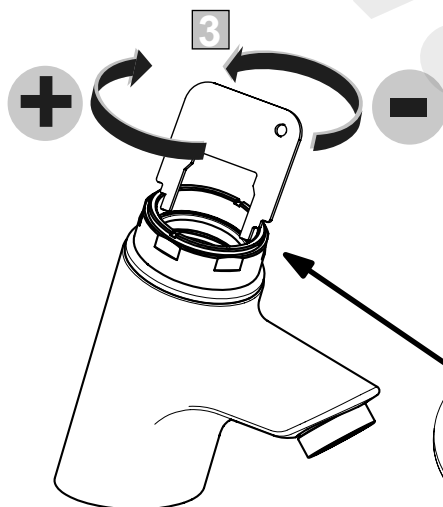
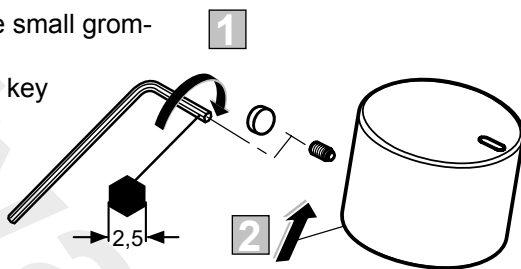

3. Adjustment

With the handle removed, engage the "run time adjustment key" (provided) into the cut-outs in the brass adjusting ring. Clockwise rotation will provide **longer** run time, & conversely anti-clockwise rotation will provide **shorter** run time. (Cartridge not shown for clarity).

4. Check run time

Replace the handle temporarily & press it to check the run time. If the run time is satisfactory secure the handle (reverse sequence above). Otherwise remove the handle & make further adjustments.

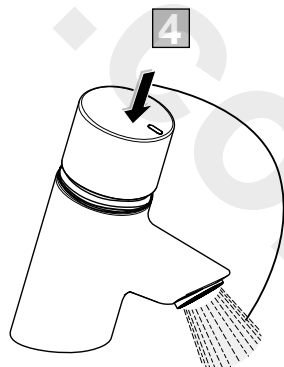

8. Maintenance (clearing pilot hole)



In the event that the tap begins to run continuously, it will be necessary to manually clear the pilot hole inside the cartridge.

Handle removal: Firstly remove the handle as detailed in section 7. ENSURE WATER SUPPLIES HAVE BEEN ISOLATED.

Remove the cartridge from the tap body as detailed in section 9.

Complete cartridge
sub assembly

Filter screen

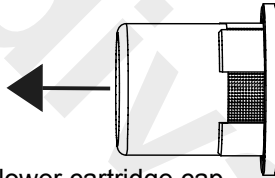
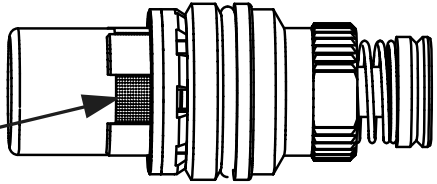

Gently pull off lower cartridge cap

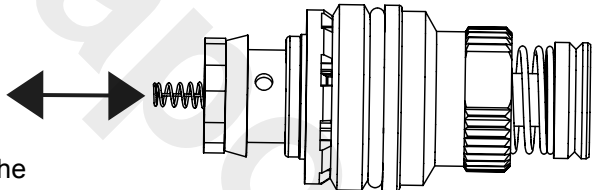
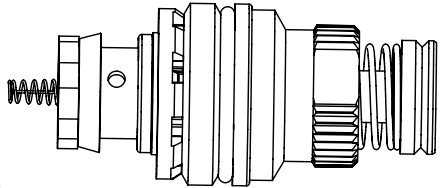

Press the spring a few times with a finger. This will exercise the pilot pin (integral to spring) and clear the pilot hole.

Before reassembling the cartridge cap, make sure that the filter screen is clean (slides out from inside of cap). When reassembling, take care to ensure the spring is straight & locates correctly into the boss at the bottom of the cap moulding.

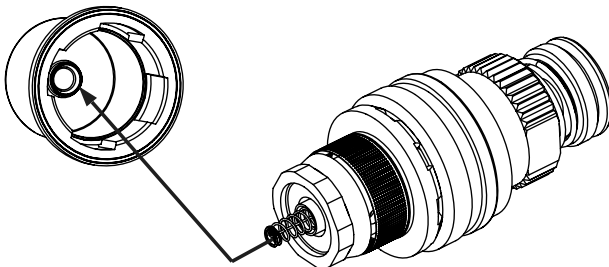

Finally refit the cartridge back into the brass housing, refit into mixer, reset the run-time & fit the handle.

9. Cartridge replacement

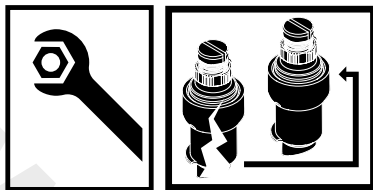

Before deciding on a replacement cartridge make sure:

1. The cartridge filter is not blocked with debris. If debris is found, clean the filter.
2. Check the pilot hole in the cartridge is clear.

For more details see section 8.

After cleaning, refit the cartridge & recheck the product

Handle removal: Firstly remove the handle as detailed in section 7 (1 & 2).
ENSURE WATER SUPPLIES HAVE BEEN ISOLATED.

3. With the handle removed, unscrew the chrome shroud using a large adjustable spanner (40mm A/F).

Lift off the chrome shroud complete with brass adjusting ring.

4. Using a 22mm A/F spanner unscrew the cartridge & remove from the tap body.

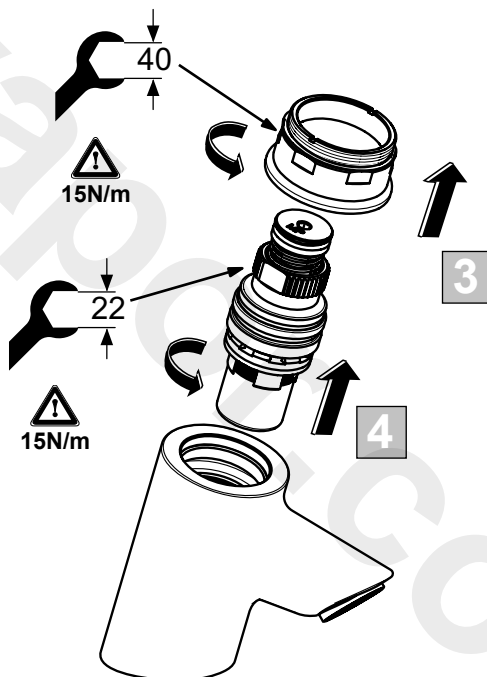

Fit a new cartridge:

replace the chrome shroud with adjusting ring.

Tighten parts to torques shown.

Adjust the run time as detailed in section 7.

Finally refit the handle.

TAKE CARE NOT TO DAMAGE CHROMED SURFACES

10. Spare parts

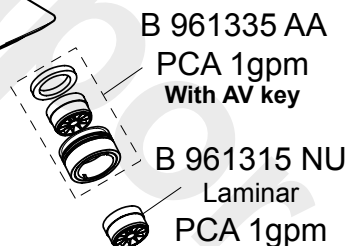
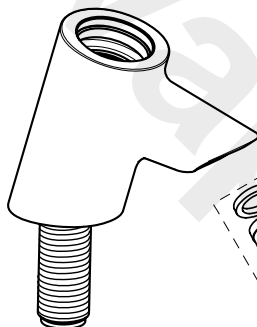
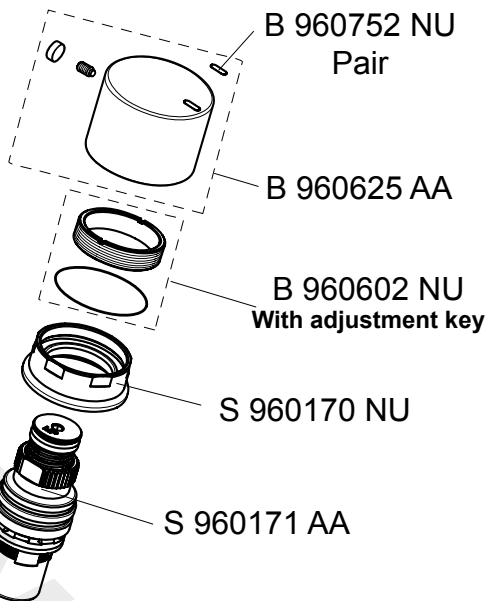
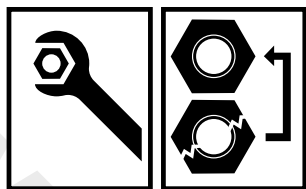

B 960799 NU

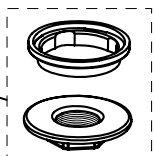

Laminar Flow straightener
spares code is:
B 960860 NU (single)
& can be obtained by contacting
Fastpart.



For more information on spares, visit our spares website:
www.fastpart-spares.co.uk. Or contact customer care.

11. Cleaning chrome surfaces

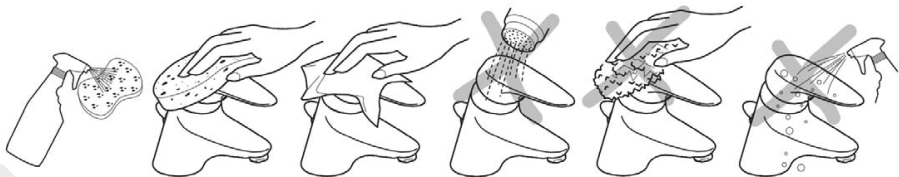

When cleaning chromed products use only a mild detergent, rinse & wipe dry with a soft cloth. Ideally clean after each use to maintain appearance.

Never use abrasive, scouring powders or scrapers. Never use cleaning agents containing alcohol, ammonia, hydrochloric acid, sulphuric acid, nitric acid, phosphoric acid, organic solvents or disinfectants.

Use of incorrect cleaning products / methods may result in chrome damage which is not covered by the manufacturer's guarantee.



Outlet cleaning

On a regular basis the outlet should be inspected & cleaned. To unscrew and remove the outlet, see section 6.

In areas where lime scale build-up is prevalent this should be avoided by regular cleaning. If it should build up, it will have to be removed. An inhibited proprietary scale solvent can be used such a kettle de-scaling solvent but it is important to follow the manufacturer's guidelines. After de-scaling it is important to rinse the parts thoroughly in clean water.

Clean carefully and do not use abrasive materials or scrapers



For more information about our products visit our websites:

www.armitage-shanks.co.uk
www.idealspec.co.uk
www.fastpart-spares.co.uk

B865288 10/17

AFTER SALES NON RESIDENTIAL HELPLINE

0870 122 8822

AFTER SALES NON RESIDENTIAL FAX

0870 122 8282

E-MAIL

aftersalesnonresidential@idealstandard.com

Armitage Shanks pursues a policy of continuing improvement in design and performance of its products. The right is therefore reserved to vary specification without notice.

Armitage Shanks is a division of Ideal Standard (UK) Ltd.

Armitage Shanks
The Bathroom Works, National Avenue
Kingston-upon-Hull, HU5 4HS England



*Armitage
Shanks*

Ideal Standard International NV
Corporate Village - Gent Building
Da Vincilaan 2
1935 Zaventem
Belgium