

GESI®

57997

GPF579970G001G000

data di validità/validity date
≥ 4/2018



COLOUR 2017

Cover di finitura estetica con illuminazione 500X500.
Cover with lighting system for 500X500 shower system.

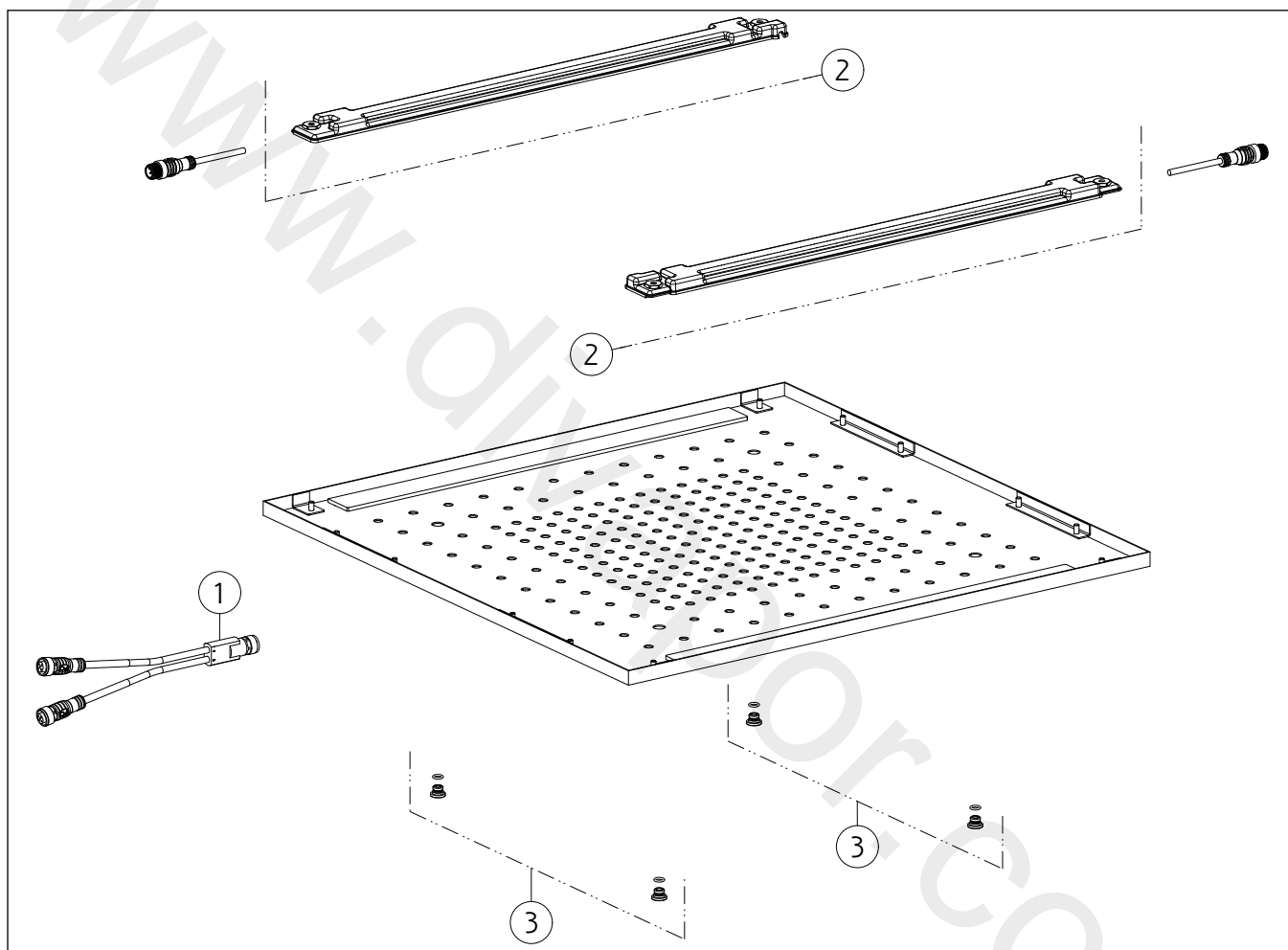

N°	Code	Descrizione	Description
1	SP01637	CAVO ELETTRICO	ELECTRICAL CABLE
2	SP01890	LED	LED
3	SP01904	VITE	SCREW