

Product Finish: Brushed nickel

Product code: AT2088  
EAN13 barcode: 5060344157124



**Product features:**

- Metal construction throughout
- Single lever control for effortless single handed control
- Urban industrial styling
- Pull out hose spout head
- Supplied complete with flexible tail pipes for fast simple fitting

**Additional information / Parts included:**

The installation of this product should respect requirement IRN R090.

Note: the image shown may not reflect the product finish, chrome finish is typically depicted.

**Product dimensions:**

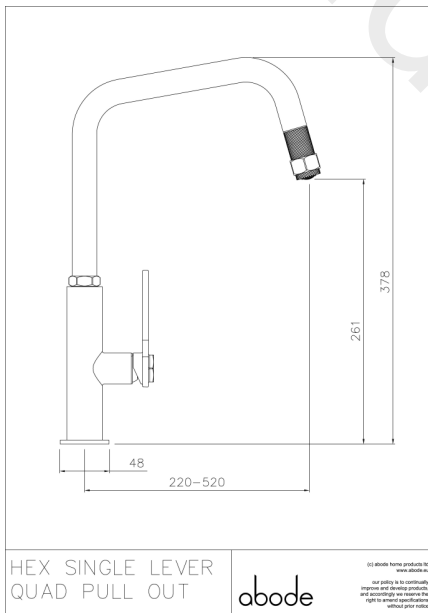

- Overall Height / projection: 378 mm
- Exit reach: 220-520 mm
- Exit height: 261 mm
- Centre distance(s):

- Base diameter(s): 48 mm
- Recommended hole diameter: Ø 35 mm
- Max. surface depth: 45 mm

- Spout diameter: 24 mm
- Spout aerator size: M22F

**Packaged properties:**

- Box length: 575mm
- Box depth: 80mm
- Box width: 350mm
- Units per outer: 5
- Tap only weight: 1.39kg
- Boxed weight: 2.40kg

**Product flow characteristics:**

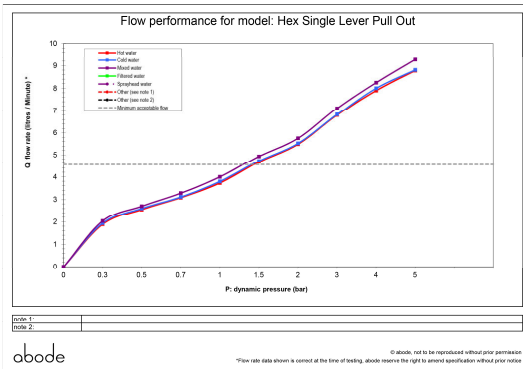

- Min / Max water pressure: 1.25 / 5.50 bar
- Recommended / Max water temperature: 46°C / 70°C
- Part G - Mixed flow rate at 3 bar (litres / min): 0.711

- Control valve type: Single lever ceramic cartridge
- Product flow characteristics: Single flow
- Non return valve(s): Integral to sprayhead, Hot and Cold inlets

- Aerator type: Honeycomb coin slot aerator
- Accepts revolve / spray areator: No
- Spout connection method: Grub screw

- Tail pipe inlet / outlet size: M8 / 1/2" BSP Male
- Inlet pipe type / length: flexible stainless braided hose / 365 mm

**Care instructions summary:**

- Clean the mixers and showers regularly as required, using soap, do not use any other cleaners.
- Regular cleaning will prevent the build-up of lime scale and dirt
- After cleaning rinse thoroughly with clean water to remove any cleaner residue
- Residues of sink & worktop cleaners can also cause damage, so rinse with clean water after using, avoid contact with any abrasives

**Warranty Summary (Full details available on request):**

- Materials and workmanship defects warranted for 5 years
- Valves and working parts warranted for 5 years
- Surface warranty defects warranted for 1 year
- O-rings, hoses & gaskets warranted for 1 year