



Product features:

- Metal construction throughout
- Custom designed for lower range pressures
- Single lever control for effortless single handed control
- Supplied complete with flexible tail pipes for fast simple fitting
- Tall spout exit height to suit free standing basins

Packaged properties:

Box length: 395 mm **Box depth:** 95 mm
Box width: 165 mm **Boxed weight:** 2.33 kg

Includes pop up waste?: No

Additional comments:

Product dimensions:

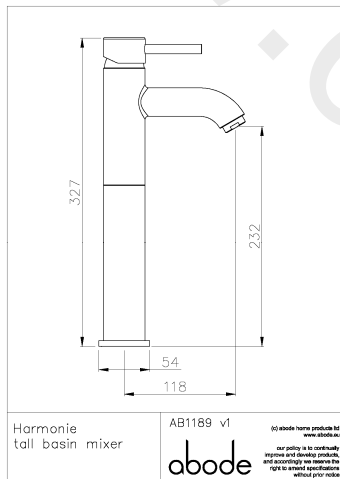

- **Overall Height / projection:** 327 mm
- **Exit reach:** 118 mm
- **Exit height:** 232 mm
- **Centre distance(s):**
- **Base diameter(s):** 54 mm
- **Product mounted where:** Surface
- **Recommended hole diameter:**
- **Min. fitting depth required:**
- **Max. surface depth:** 80 mm

Product flow characteristics:

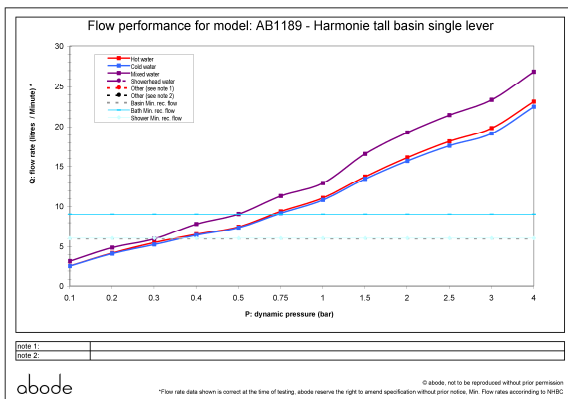

- **Min / Max water pressure:** 0.3 / 5 bar
- **Part G mixed flow rate at 3 bar (l/m):** 23.3
- **Max water temperature:** 70° C
- **Product flow characteristics:** Single flow
- **Aerator type:** White flow straightener
- **Includes output diverter?:** No
- **Control valve type:** Single lever (35mm)
- **Non return valve position:**
- **Mesh particle filter size:**
- **Inlet / outlet size:** 1/2" F / m10
- **Inlet type / length:** Flexible / 520 mm
- **Shower hose type / length:**

Warranty Summary (Full details available on request):

- Materials and workmanship defects warranted for 5 years
- Valves and working parts warranted for 5 years
- Surface warranty defects warranted for 1 year
- O-rings, hoses & gaskets warranted for 1 year

Care instructions:

- Clean the mixers and showers regularly as required, using soap, do not use any other cleaners.
- Regular cleaning will prevent the build up of lime scale and dirt
- After cleaning rinse thoroughly with clean water to remove any cleaner residue
- Residues of liquid soaps, shampoos and shower foams can also cause damage, so rinse with clean water after using, avoid contact with any abrasives