



Product features:

- Luscious European quality chromium plate finish
- Rub clean anti limescale spray nozzles
- Single spray pattern showerhead
- Elegant minimalist design styling with a softened edge
- Swivel showerhead connector for maximum flexibility

Packaged properties:

Box length (mm): 265 Box depth(mm): 80
Box width(mm): 250 Boxed weight (Kg): 0.86

Includes pop up waste?: N/A

Additional comments:

Product dimensions:

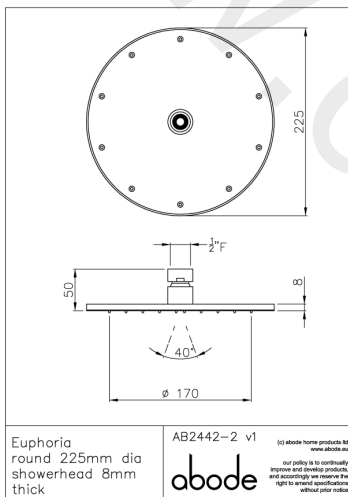

- Product mounted where: Roof / wall
- Recommended hole size: N/A mm
- Overall Height / projection: 50 mm
- Exit reach: N/A mm
- Exit height: 50 mm
- Base size: N/A mm
- Inlet centre distance(s): N/A mm

- Min. fitting depth required: N/A mm/N/A mm
- Max. surface depth: N/A

Product flow characteristics:

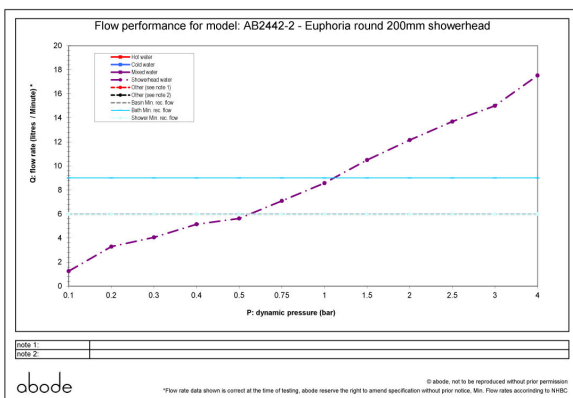

- Min / Max water pressure (bar): 0.55* / 5.00
- Part G max. mixed flow rate at 3 bar (l/m): 15
- Inlet connection type / length: Fixed / N/A mm
- Inlet (plumbing connection) / outlet size: 1/2" F / TBC
- Product flow characteristics: N/A
- Non return valve(s) supplied or position: No
- Aerator type: Clear silicone rub clean nozzles
- Control valve type: N/A (N/A)
- Includes output diverter?: N/A
- Inlet meshed particle filters included: 0.60 mm
- Shower hose type / length: N/A / N/A

Warranty Summary (full details available on request):

- Materials and workmanship defects warranted for 5 years
- Valves and working parts warranted for 5 years
- Surface warranty defects warranted for 1 year
- O-rings, hoses & gaskets warranted for 1 year

Care instructions:

- Clean the mixers and showers regularly as required, using soap, do not use any other cleaners.
- Regular cleaning will prevent the build-up of lime scale and dirt
- After cleaning rinse thoroughly with clean water to remove any cleaner residue
- Residues of liquid soaps, shampoos and shower foams can also cause damage, so rinse with clean water after using, avoid contact with any abrasives