

Talis S
Single lever shower mixer for exposed installation 2 ticks
 Finish: **Chrome** Article Number: **72608009**



Description

product features

- centre distance: 150 ± 12 mm
- flow rate of hand shower at 3 bar: 5,3 l/min
- ceramic cartridge
- temperature limitation adjustable
- non-return valve
- with silencer
- hose connection DN15
- connection dimension: DN15
- min. operating pressure: 1 bar
- max. operating pressure: 10 bar
- connection type: s-shaped connections

Product image



Scale drawing

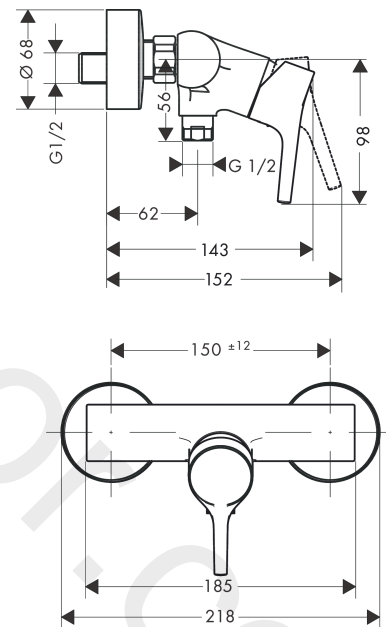

Flowchart

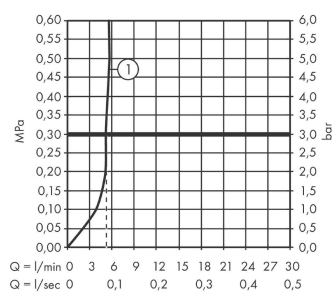

Talis S
Single lever shower mixer for exposed installation 2 ticks
 Finish: **Chrome** Article Number: **72608009**



Exploded Drawing

Year of production: >04/20

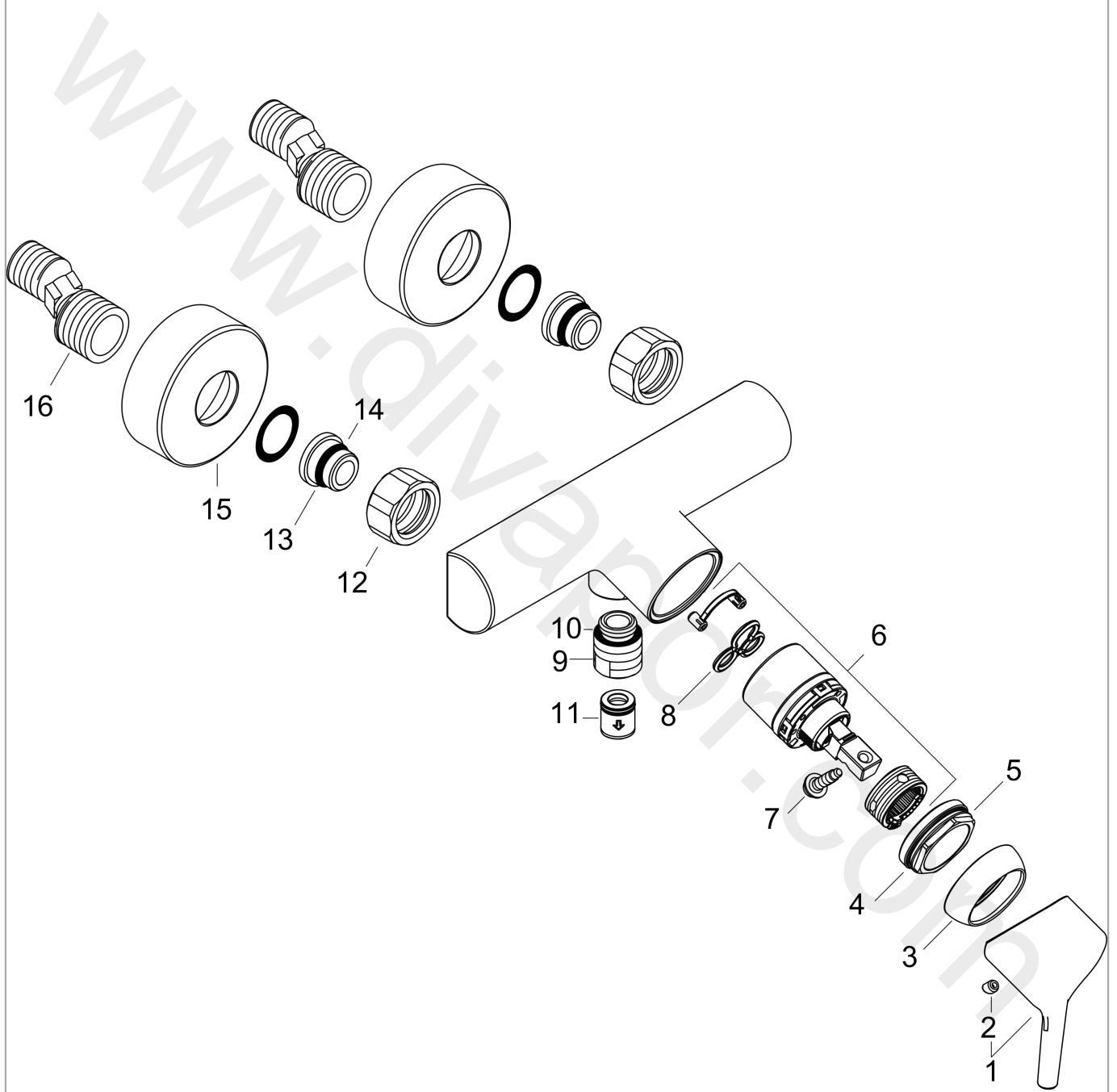

Talis S
Single lever shower mixer for exposed installation 2 ticks
 Finish: **Chrome** Article Number: **72608009**



Spare part list

Year of production: >04/20

Pos.	Description	Article Number	Price	PU
1	handle	92644000	£ 35,00	1
2	screw cover	96338000	£ 3,30	1
3	flange	97406000	£ 20,50	1
4	nut	97209000	£ 16,10	1
5	O-Ring 32x2	98193000	£ 3,30	1
6	cartridge, assy	95646000	£ 96,00	1
7	locking screw for handle	95140000	£ 6,10	1
8	seal	95008000	£ 9,00	1
9	Hose Connection	96044019	-	1
10	O-ring 14x2	98129000	£ 3,30	1
11	non return valve	92839000	£ 16,10	1
12	set of nuts	96157000	£ 35,00	1
13	connecting thread	97220000	£ 16,10	1
14	O-ring 15x2	98163000	£ 3,30	1
15	escutcheon Ø 68 mm	96467000	£ 20,50	1
16	set of S-unions	94140007	-	1