

AXOR One
Shut-off valve for concealed installation
Surfaces: Article Number: **45771930**

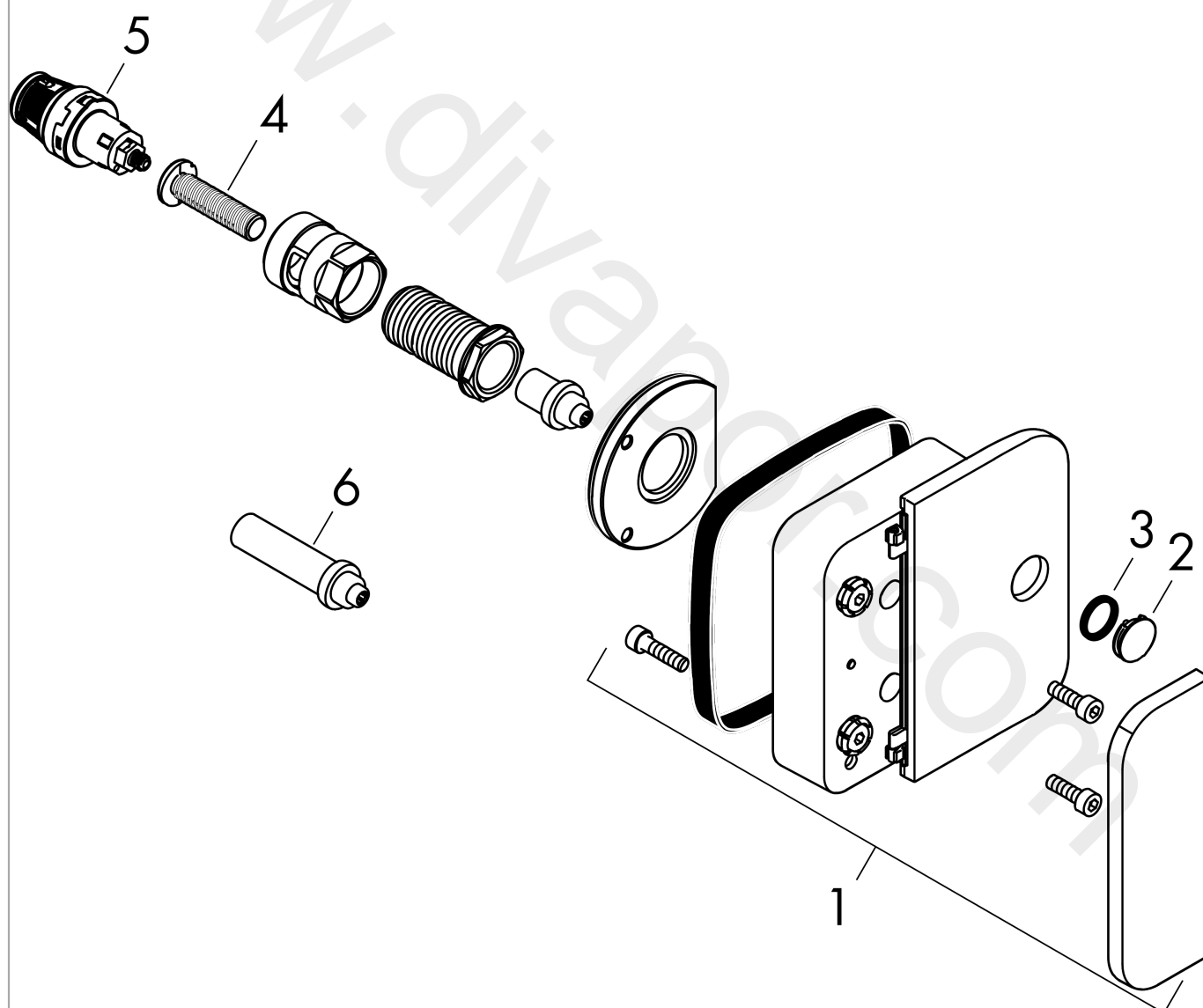

Exploded Drawing

Year of production: 11/16 - 12/19



AXOR One
Shut-off valve for concealed installation
 Surfaces: Article Number: **45771930**



Spare part list

Year of production: **11/16 - 12/19**

Pos.		Article Number	Price	PU
1	escutcheon with handle	92743930	£ 555,00	1
2	set of symbols	92541930	£ 163,00	1
3	O-ring 13x2	98128000	£ 3,30	1
4	Select-adapter	92219000	£ 6,10	1
5	shut off unit	95758000	£ 110,00	1
6	extension 25 mm	93421000	£ 64,00	1
a	base body	45770180	£ 275,00	1