

AXOR One
Thermostatic module for concealed installation for 1 function
Surfaces: Article Number: **45711130**

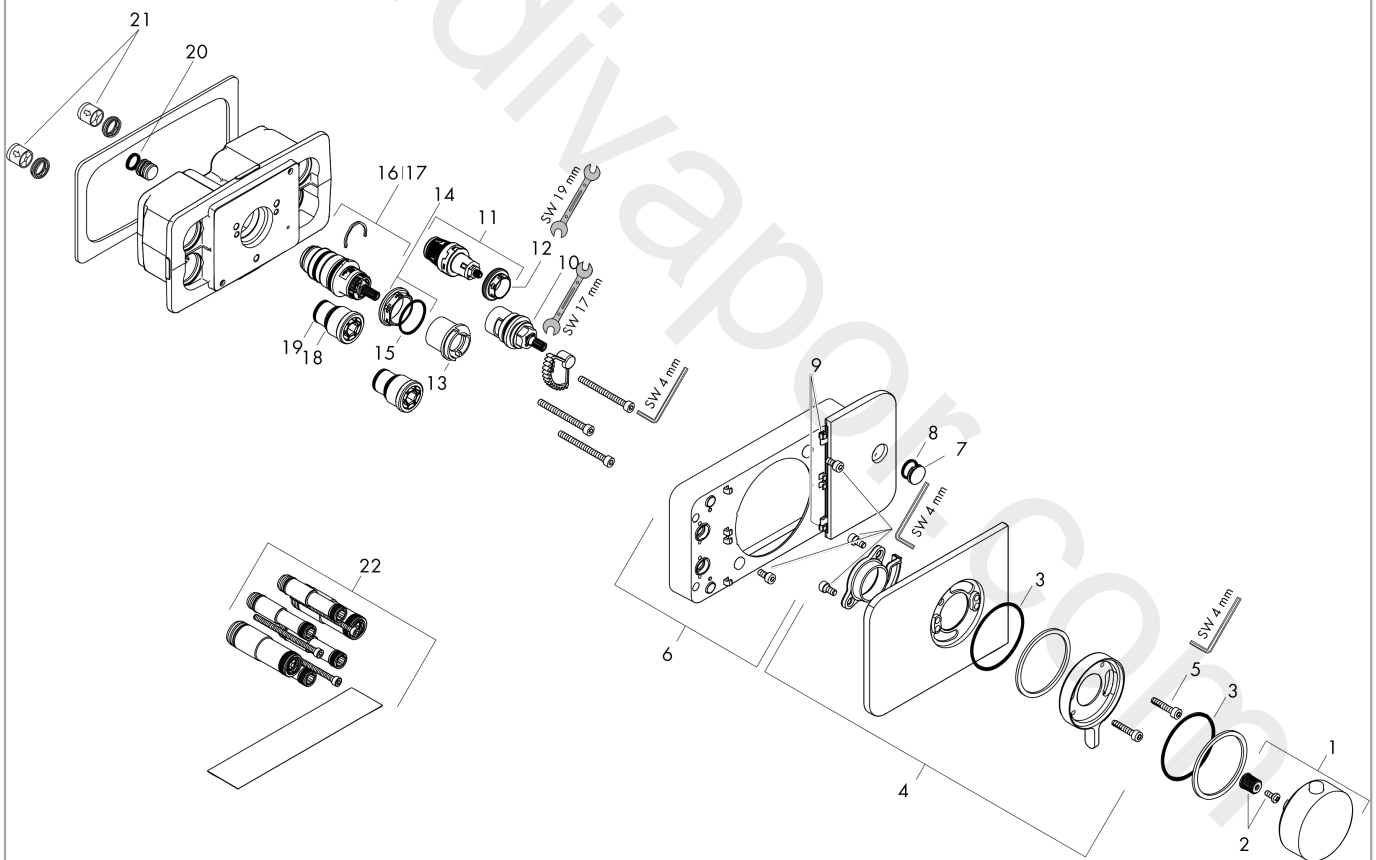

Exploded Drawing

Year of production: **11/16 - 12/19**



AXOR One
Thermostatic module for concealed installation for 1 function
 Surfaces: Article Number: **45711130**



Spare part list

Year of production: **11/16 - 12/19**

Pos.		Article Number	Price	PU
1	handle for thermostat	92600130	£ 205,50	1
2	handle fixing set	98932000	£ 16,10	1
3	O-ring 57x2	98210000	£ 3,30	1
4	escutcheon	92598130	£ 205,50	1
5	hexagon socket screw M5x25	97664000	£ 3,30	1
6	control panel	92611130	£ 412,50	1
7	set of symbols	92541130	£ 163,00	1
8	O-ring 13x2	98128000	£ 3,30	1
9	set of lever collars	93121000	£ 3,30	1
10	shut off unit	98536000	£ 79,00	1
11	shut off unit	95758000	£ 110,00	1
12	nut	98368000	£ 13,30	1
13	safety set	92614000	£ 35,00	1
14	nut	98913000	£ 20,50	1
15	O-ring 26x1,5	98390000	£ 3,30	1
16	thermostat cartridge	98282000	£ 110,00	1
17	cartridge for exchanged connections	92373000	£ 275,00	1
18	O-ring 21x1,5	98219000	£ 3,30	1
19	O-ring 17x1,5	98137000	£ 3,30	1
20	O-ring 11x2	98127000	£ 3,30	1
21	non return valve (pressure-resistant up to 2 MPa)	92594000	£ 16,10	1
22	extension 25 mm	45790000	£ 305,00	1
a	base body	45710180	£ 435,00	1