

**AXOR Uno**  
**Single lever basin mixer 80 with zero handle and waste set**  
 Finish: **Chrome** Article Number: **45005000**



### product features

- consists of: single lever basin mixer, waste set
- ComfortZone 80
- projection: 108 mm
- spout height: 79 mm
- handle variant: cylinder handle
- spray type: laminar spray
- maximum flow rate at 3 bar: 5 l/min
- ceramic cartridge
- temperature limitation adjustable
- suitable for continuous flow water heaters
- non-closing waste set
- connection type: G 3/8 connections
- connection dimension: DN15
- EU taxonomy: max. 6 l/min - Substantial Contribution (SC) possible

### Article Details

Price excl. VAT 404,17 £

### Technology



### Product image



### Scale drawing

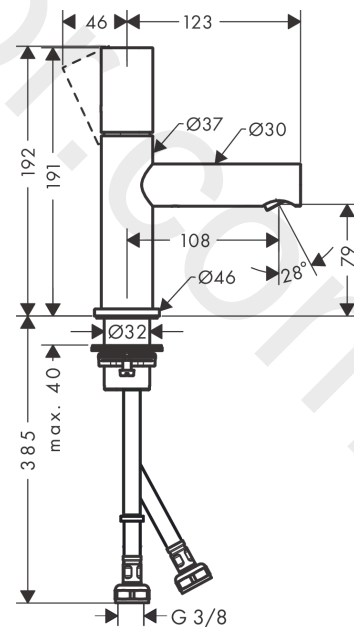

**AXOR Uno**  
**Single lever basin mixer 80 with zero handle and waste set**  
 Finish: **Chrome** Article Number: **45005000**



## Flowchart

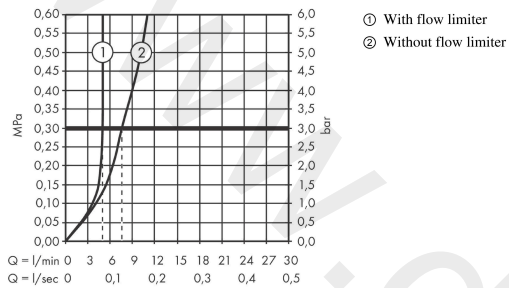

**AXOR Uno**  
**Single lever basin mixer 80 with zero handle and waste set**  
Finish: **Chrome** Article Number: **45005000**



## Exploded Drawing

Year of production: >10/18

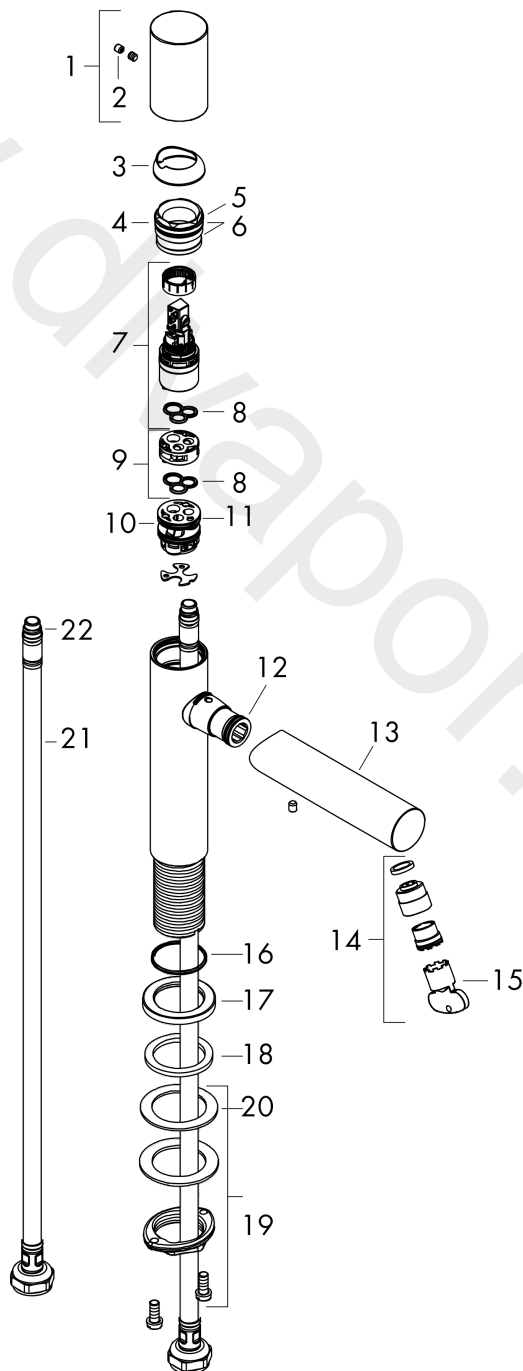

**AXOR Uno**  
**Single lever basin mixer 80 with zero handle and waste set**  
 Finish: **Chrome** Article Number: **45005000**



## Spare part list

Year of production: >10/18

Pos.		Article Number	Price	PU
1	handle	92887000	£ 173,00	1
2	screw cover	95181000	£ 3,30	1
3	flange	93116000	£ 25,00	1
4	nut	92689000	£ 25,00	1
5	O-ring 25x1,5	98146000	£ 3,30	1
6	O-ring 27x1,5	92527000	£ 13,30	1
7	cartridge, assy	97685000	£ 64,00	1
8	seal	98865000	£ 35,00	1
9	adapter for cartridge	92628000	£ 20,50	1
10	adapter for cartridge	98866000	£ 35,00	1
11	O-ring 23x2	98398000	£ 3,30	1
12	O-ring 16x2	98133000	£ 3,30	1
13	spout cpl.	92892000	£ 224,00	1
14	aerator laminar M18x1 (5 l/min)	92896000	£ 51,00	1
15	special tool	98987000	£ 9,00	1
16	O-ring 30x1,5	98433000	£ 3,30	1
17	escutcheon Ø 46 mm	95268000	£ 25,00	1
18	flat seal	98749000	£ 6,10	1
19	fixing set (Ø 32)	13961000	£ 25,00	1
20	lever collar	97548000	£ 3,30	1
21	connection hose 450 mm M8x0,75 G3/8	97206000	£ 35,00	1
22	O-ring 6,6x1,6	93019000	£ 3,30	1
a	waste	50001000	£ 71,00	1
b	fixation extension 35 mm	13898000	£ 79,00	1