

AXOR Uno²
Single lever bath mixer for concealed installation
 Surfaces: Article Number: **38425000**

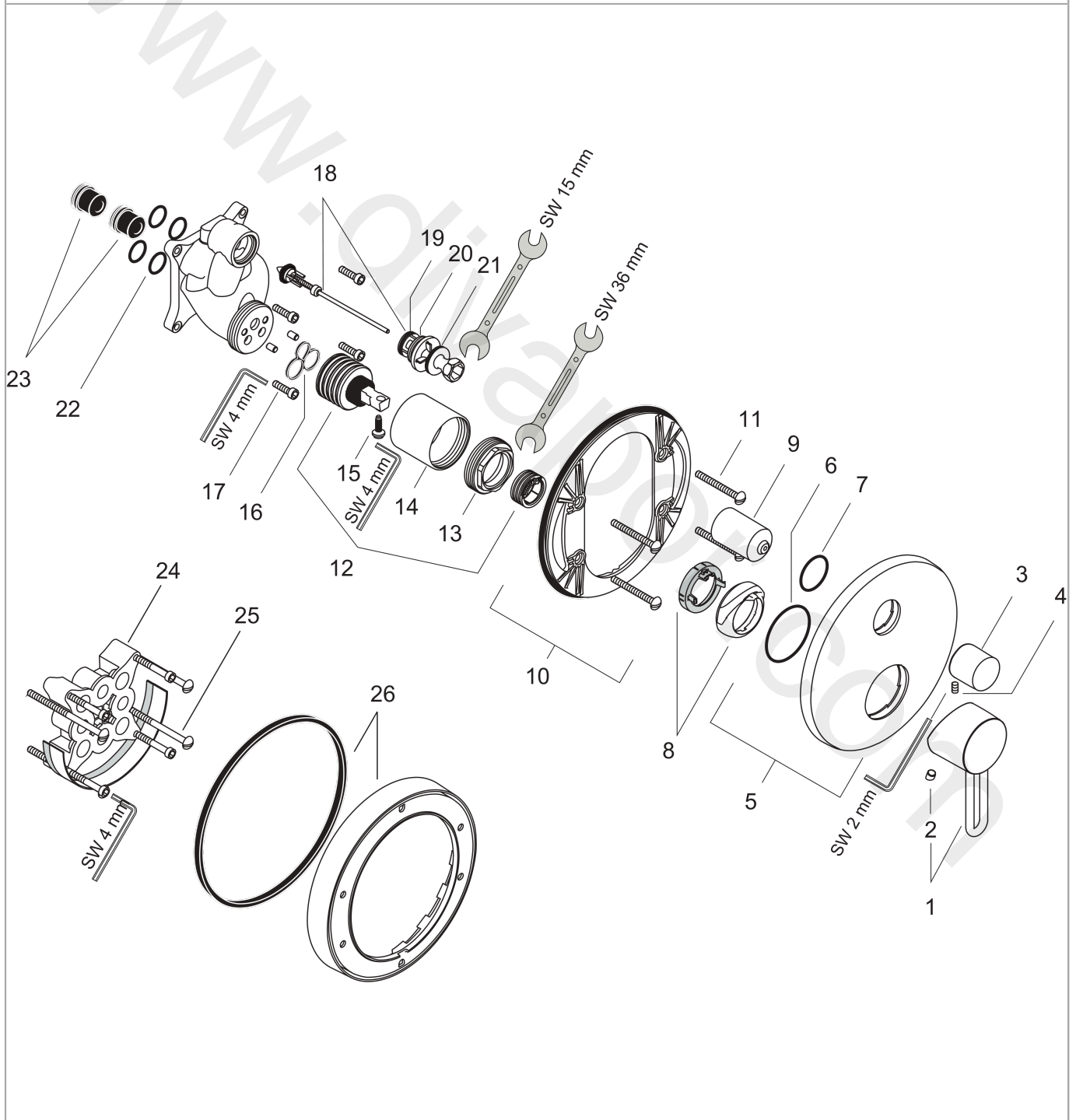

Exploded Drawing

Year of production: **05/10 - 05/11**



AXOR Uno²
Single lever bath mixer for concealed installation
 Surfaces: Article Number: **38425000**



Spare part list

Year of production: **05/10 - 05/11**

Pos.		Article Number	Price	PU
1	handle	98553000	£ 96,00	1
2	screw cover	96338000	£ 3,30	1
3	diverter knob	96473000	£ 51,00	1
4	hollow set screw M4x10	97667000	£ 3,30	1
5	escutcheon Ø 170 mm	96453000	£ 64,00	1
6	O-Ring 48x3	95508000	£ 3,30	1
7	O-ring 29x3	98371000	£ 6,10	1
8	flange (Rotating Protector)	96395000	£ 43,00	1
9	sleeve	96448000	£ 43,00	1
10	sub plate	96447000	£ 51,00	1
11	set of fixing screws	96454000	£ 9,00	1
12	cartridge, assy	92730000	£ 35,00	1
13	nut	96461000	£ 35,00	1
14	sleeve	98713000	£ 51,00	1
15	locking screw for handle	95140000	£ 6,10	1
16	seal	95008000	£ 9,00	1
17	set of screws	96525000	£ 9,00	1
18	selector assy	95014000	£ 64,00	1
19	O-ring 16x2,3	98207000	£ 3,30	1
20	O-ring 20x2,5	92602000	£ 6,10	1
21	O-ring 21x2	98205000	£ 6,10	1
22	O-ring 16x2	98133000	£ 3,30	1
23	noise reduction	94073000	£ 25,00	1
24	extension 25 mm	13595000	£ 75,00	1
25	set of fixing screws	97747000	£ 3,30	1
26	extension 22 mm (Ø 170 mm)	13596000	£ 72,00	1
a	concealed item	01800180	£ 163,00	1
b	spring for exchanged connections	96365000	£ 43,00	1