

AXOR Citterio E
3-hole basin mixer 170 with escutcheons and pop-up waste set
 Surfaces: Article Number: **36108930**

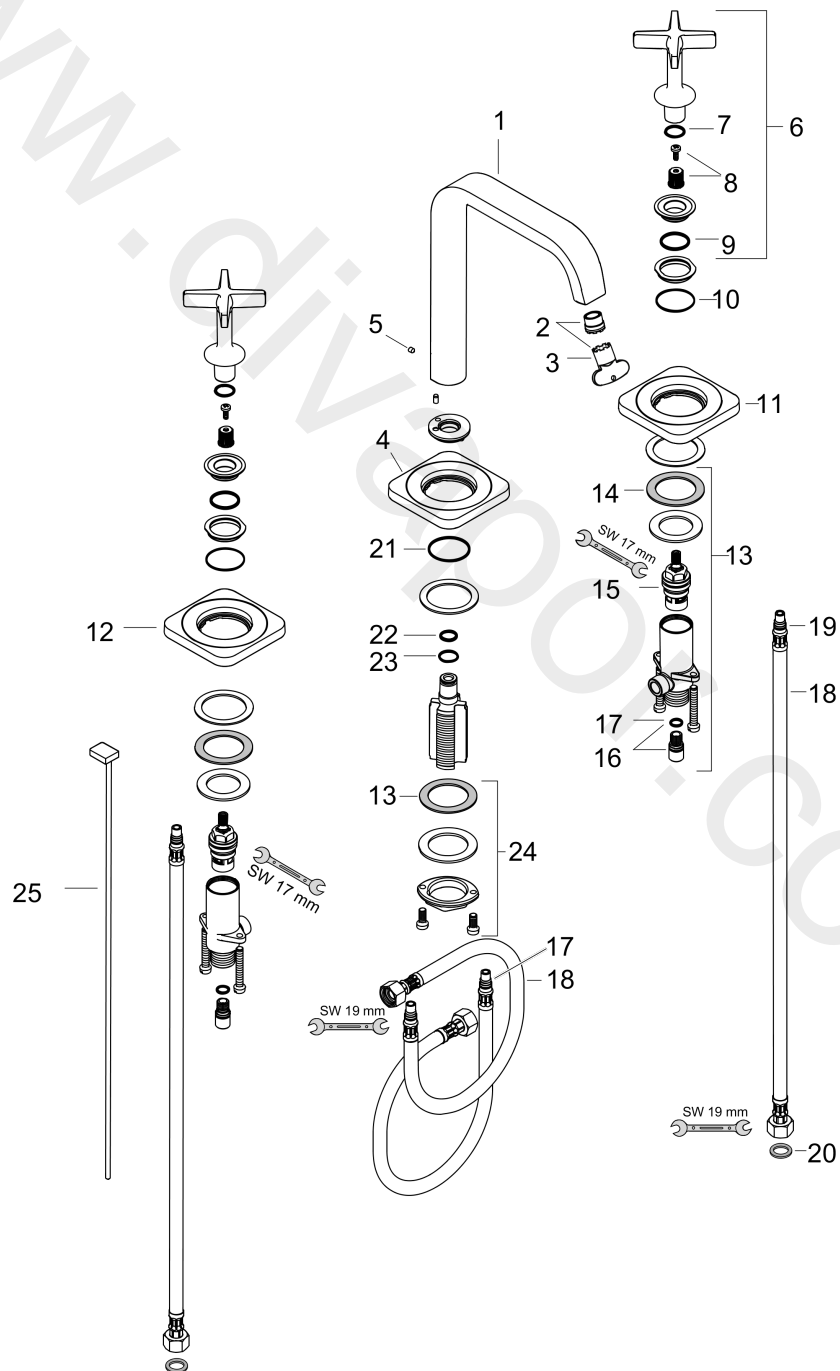

Exploded Drawing

Year of production: **11/16 - 12/19**



AXOR Citterio E

3-hole basin mixer 170 with escutcheons and pop-up waste set

Surfaces: Article Number: **36108930**



Spare part list

Year of production: **11/16 - 12/19**

Pos.		Article Number	Price	PU
1	spout cpl.	92394930	£ 667,50	1
2	aerator laminar M16,5x1 (5 l/min)	95382000	£ 43,00	1
3	special tool	98987000	£ 9,00	1
4	escutcheon	98930930	£ 96,00	1
5	hollow set screw M4x5	92846000	£ 13,30	1
6	handle	92396930	£ 144,00	1
7	O-ring 13x2	98128000	£ 3,30	1
8	handle fixing set	98932000	£ 16,10	1
9	O-ring 21x2	98205000	£ 6,10	1
10	O-ring 30x1,5	98433000	£ 3,30	1
11	escutcheon cold water	92398930	£ 205,50	1
12	escutcheon hot water	92397930	£ 205,50	1
13	stop valve cpl.	97357000	£ 137,00	1
14	lever collar	97548000	£ 3,30	1
15	shut off unit	94149000	£ 35,00	1
16	set of connecting threads	98350000	£ 6,10	1
17	O-ring 8x1,5	98423000	£ 3,30	1
18	connection hose 450 mm M8x0,75 G3/8	97206000	£ 35,00	1
19	O-ring 7x1,5	98422000	£ 3,30	1
20	sealing set	95581000	£ 6,10	1
21	O-ring 11x2	98127000	£ 3,30	1
22	O-Ring 14x1,5	98201000	£ 3,30	1
23	fixing set (Ø 32)	13961000	£ 25,00	1
24	pop up rod	92395930	£ 64,00	1
a	fixation extension 35 mm	13898000	£ 79,00	1
b	pop up waste	94139930	£ 163,00	1