

Shower - VAIA

Wall valve clockwise closing 1/2"

Article number: 36 607 819-06

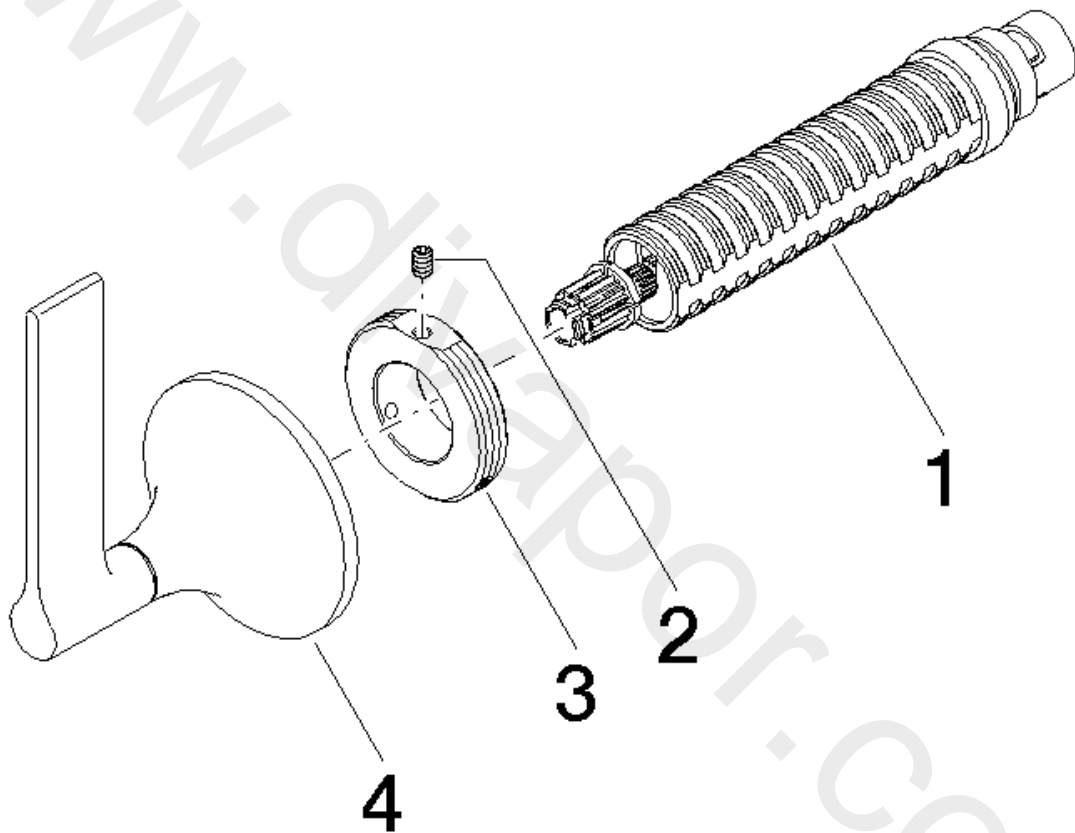

Spare parts list

Position	Quantity used	Item Number	Spare part	Delivery time
1	1	90 90 03 143 00 90	top	2
2	1	09 31 11 008 90	pin	2
3	1	09 21 02 163 90	disc	2
4	1	90 20 80 015 00-06	handle	10



Shower - VAIA

Wall valve clockwise closing 1/2"

Article number: 36 607 819-06

www.divapor.com