

Sink - VAIA

Single-lever lavatory mixer with drain - Chrome

Article number: 33 510 809-00 0010

Date of manufacture from 3/13/2017

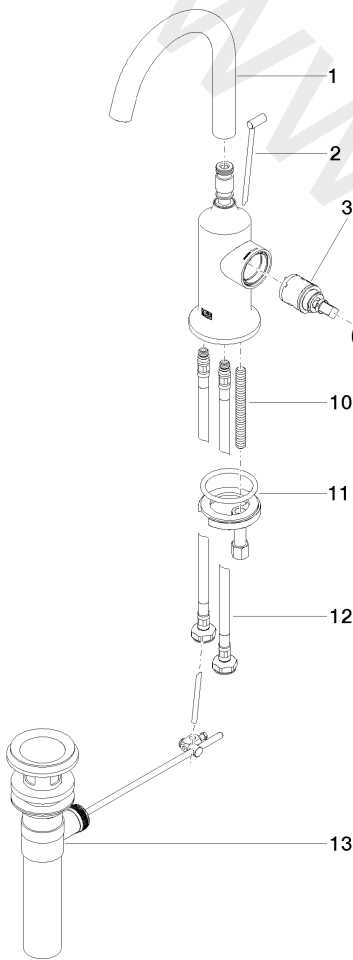



Sink - VAIA

Single-lever lavatory mixer with drain - Chrome

Article number: 33 510 809-00 0010

Date of manufacture from 3/13/2017

Spare parts list

Position	Number of units	Item Number	Spare part	Lead time
1	1	90 28 22 312 01-00	spout	10
2	1	04 20 89 035 80-00	pull-rod	10
3	1	90 15 05 042 00 90	cartridge	2
4	1	09 24 04 266 90	nut	2
5	1	09 14 10 091 90	seal	2
6	1	09 28 30 021-00	cover	10
7	1	09 20 80 020-00	handle	10
8	1	09 31 11 030 90	pin	2
9	1	90 31 20 087 00-00	plug	10
10	1	09 31 11 011 90	pin	2
11	1	04 30 11 038 00 90	fixing set	2
12	2	04 30 04 102 00 90	Flexible supply line 3/8" -	2
13	1	04 11 01 023 00-00	Drain US 1 1/4" - Chrome	2