

USER MAINTENANCE

Cleaning

Many household cleaners contain abrasives and chemical substances, and should not be used for cleaning plated or plastic fittings. These finishes should be cleaned with a mild washing up detergent or soap solution, and then wiped dry using a soft cloth.

SPECIFICATION - PRESSURES

Minimum maintained pressure: 0.1 bar (10 kPa) - Maximum maintained pressure: 5.0 bar (500 kPa)

SPARE PARTS

Basin / Bath Pillar

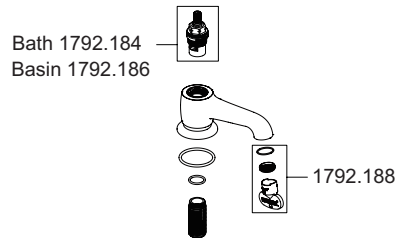

Bath Filler / Bath Shower Mixer

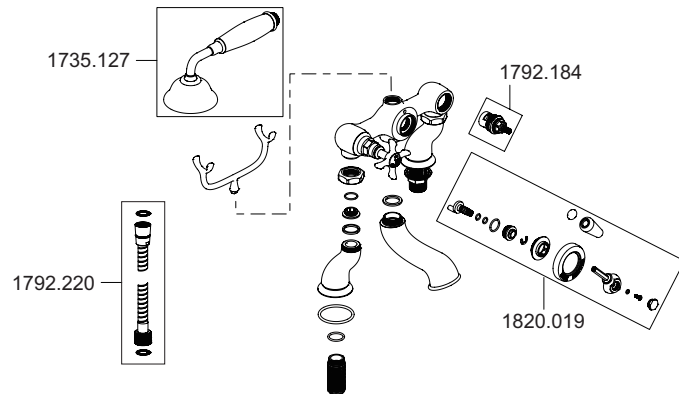

CUSTOMER SERVICE

Guarantee

Your product has the benefit of our manufacturer's guarantee which starts from the date of purchase. This guarantee only applies in the United Kingdom and Republic of Ireland.

Within the guarantee period we will resolve defects in materials or workmanship, free of charge, by repairing or replacing parts or product as we may choose.

This guarantee is in addition to your statutory rights and is subject to the following conditions:

The guarantee applies solely to the original installation under normal use and to the original purchaser only.

The product must be installed and maintained in accordance with the instructions given in this guide.

Replacement under this guarantee does not extend the original expiry date.

The guarantee on any replacement parts or product ends at the original expiry date.

The guarantee does not cover:

Non product faults (such as damage or performance issues arising from incorrect installation, improper use, inappropriate cleaning, lack of maintenance, build up of limescale, frost damage, corrosion, chemical attack, system debris or blocked filters) or where no fault has been found with the product.

Water or electrical supply, waste and isolation issues.

Compensation for loss of use of the product or consequential or indirect loss of any kind.

Wear and Tear.

Accidental or wilful damage.

Products purchased ex-showroom display.

What to do if something goes wrong

If your product does not function correctly when you first use it, contact your installer to check that it is installed in accordance with the instructions in this manual. If this does not resolve the issue, contact us for help and advice.

Helpdesk Service

Ring our Customer Services Team for product advice, to purchase spare parts or accessories. We will need you to have your model name or number and date of purchase.

Mira Showers Website
(www.mirashowers.co.uk)

From our website you can download additional user guides, diagnose faults, purchase our full range of accessories and popular spares and refer to our FAQ's.

Spares and Accessories

We hold the largest stocks of genuine Mira spares and accessories.

Contact us for a price or visit our website to purchase items from our accessory range and popular spares (Only available in the United Kingdom).

To Contact Us: UK

Telephone: 0844 571 5000

Fax: 01242 282595

Email – Visit www.mirashowers.co.uk/contactus

By Post: Mira Customer Services
Dept, Cromwell Road, Cheltenham,
Gloucestershire GL52 5EP

To Contact Us: Eire Only

Telephone: 01 531 9337

E-mail: CustomerServiceEire@mirashowers.com

Mira Virtue Taps

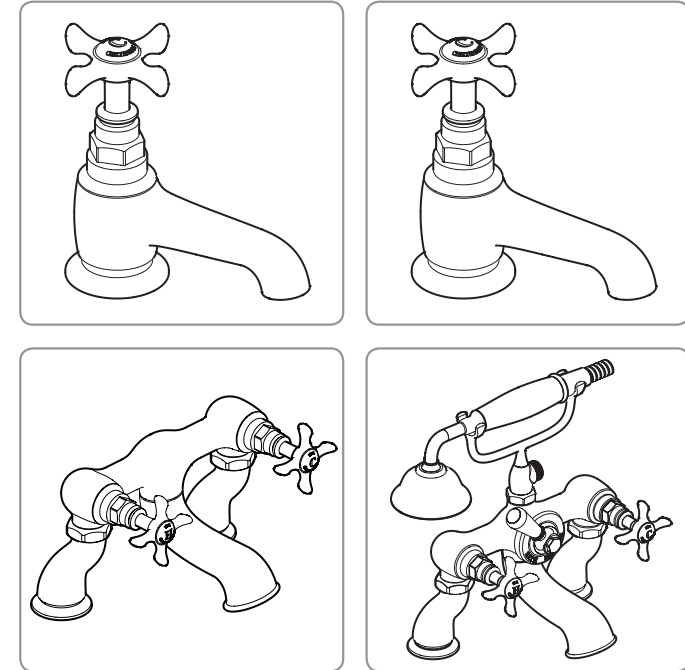

TOOLS REQUIRED

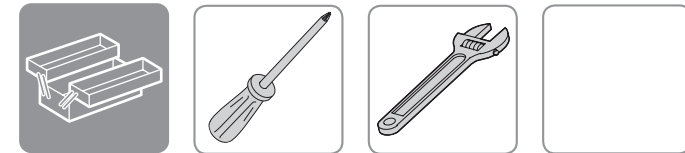

GENERAL

Make sure that the item is installed by a competent installer.

Shut off the main water supply.

The installation must comply with the "Water Supply Regulations 1999 (Water Fittings)" or any particular regulations and practices specified by the local water company or water undertakers.

These instructions must be left with the user

Mira is a registered trade mark of Kohler Mira Limited.

The company reserves the right to alter product specifications without notice.

www.mirashowers.co.uk

mira
SHOWERS

Installation and User Guide

Showering perfection

mira
SHOWERS

PATENTS

Design Registration: 001352462

GUARANTEE

Guarantee

The Mira Virtue has been designed for domestic use only, Mira Showers guarantee the Mira Honesty against any defect in materials or workmanship for a period of **five** years from the date of purchase.

For non-domestic installations, Mira Showers guarantee the Mira Virtue against any defect in materials or workmanship for a period of **one** year from the date of purchase.

For terms and conditions, refer to the back cover of this guide.

Recommended Usage

Domestic	✓
Light Commercial	✓
Heavy Commercial	✗
Healthcare	✗

INSTALLATION

Basin Pillar / Bath Pillar



1

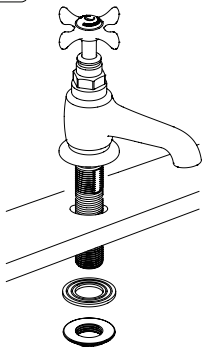

2

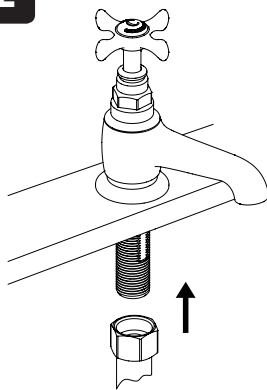

Bath Filler

Water supplies shall be at reasonably balanced pressures from a common source (e.g. hot and cold supplies both from the same storage or both from a supply pipe). Where the fitting is supplied from unbalanced supplies (e.g. hot and cold supplies from separate sources) an **'Approved' single check valve** or some other no less effective backflow prevention device shall be fitted immediately upstream of both hot and cold water inlets.

Bath Shower Mixer

Because the shower hose and handset is capable of dropping below the spill-over level of the bath which could lead to contamination from back-siphonage of Fluid Category 3 water, an **'Approved' single check valve** or some other no less effective backflow prevention device shall be fitted immediately upstream of both hot and cold water inlets.

A minimum gap of 40 mm is required between the showerhead and the spillover level of any toilet, bidet or other appliance with a Fluid Category 5 backflow risk.

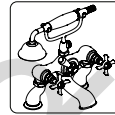
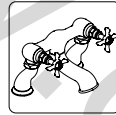

1

2

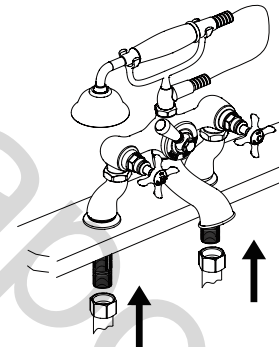
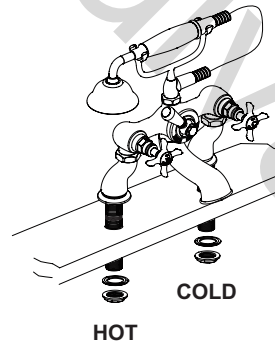

3

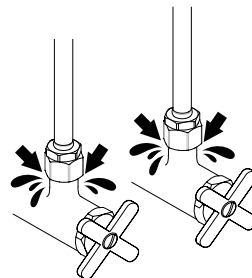

4

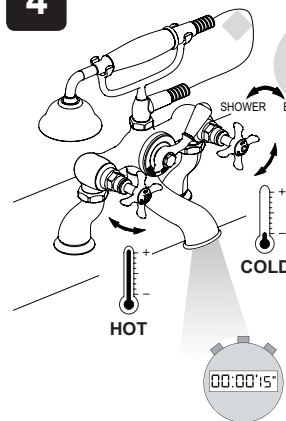

5

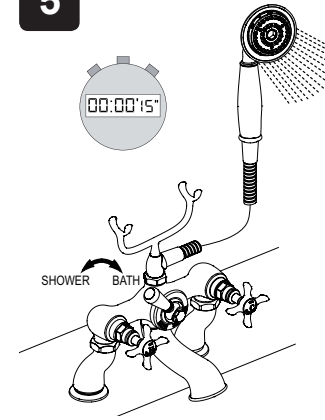

6

