

Basic set for thermostatic module Select for 3 functions

Finish: n.a. Article Number: 18311181



product features

- 3 functions
- connection thread NPT 3/4"
- connection dimension: DN15/DN20
- horizontal installation
- sound-decoupled installation
- minimum mounting depth: 87 mm
- maximum mounting depth: 122 mm

Product image



Scale drawing

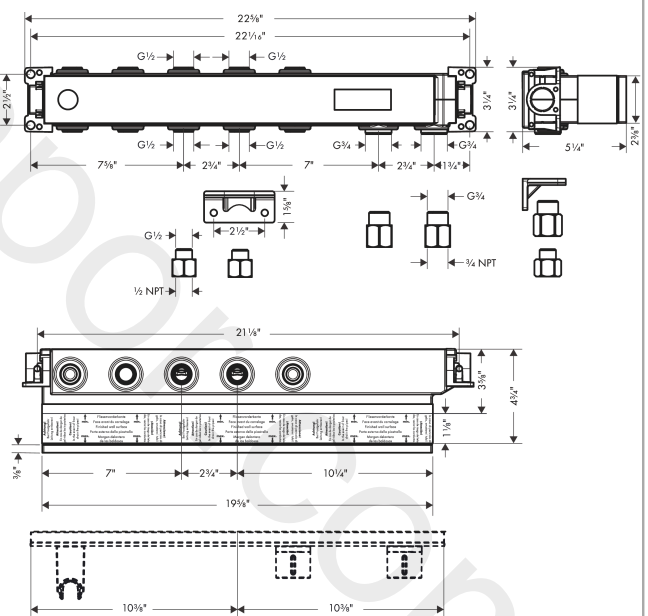

Basic set for thermostatic module Select for 3 functions
Finish: n.a. Article Number: 18311181



Exploded Drawing

Year of production: >01/20

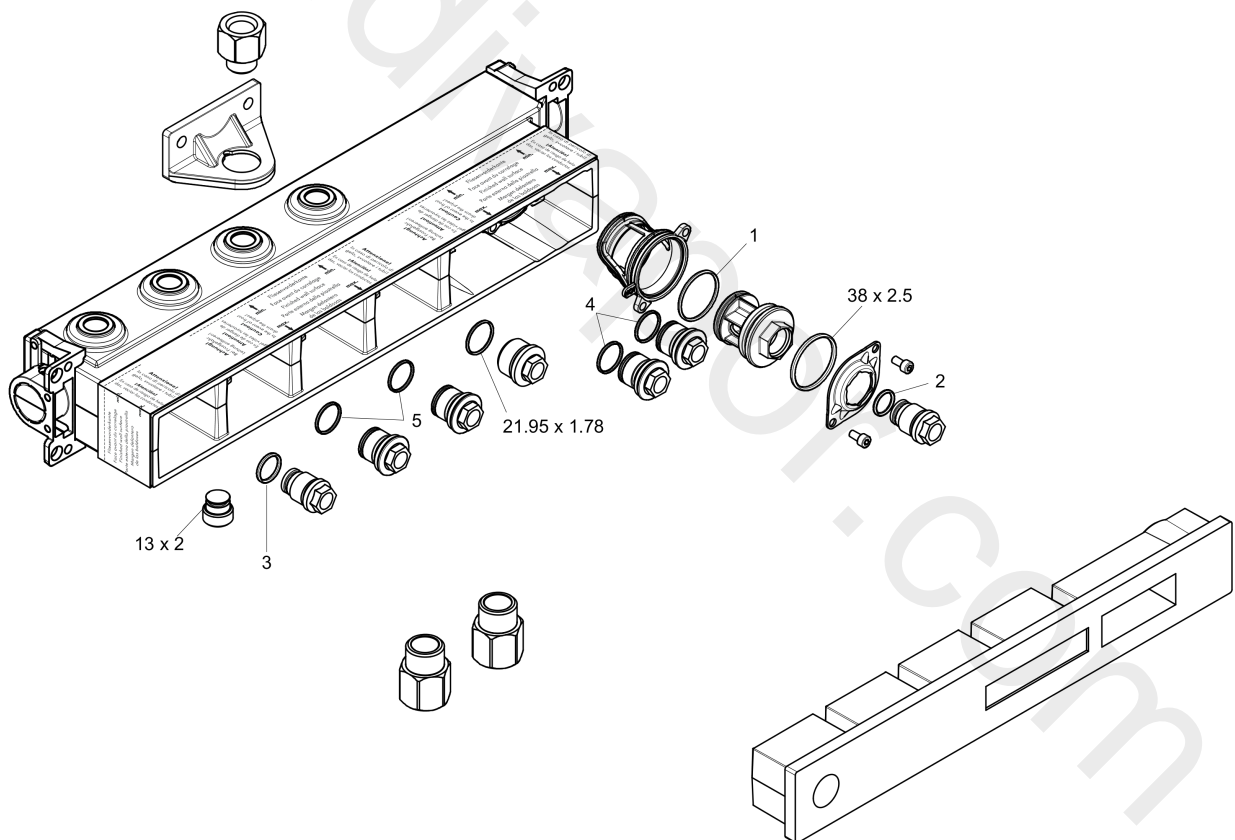

Basic set for thermostatic module Select for 3 functions

Finish: n.a. Article Number: 18311181



Spare part list

Year of production: >01/20

Pos.		Article Number	Price	PU
1	O-ring 34x2	98383000	£ 6,10	1
2	O-ring 15x2	98163000	£ 3,30	1
3	O-ring 18x2	98181000	£ 6,10	1
4	O-ring 20x2	98165000	£ 3,30	1
5	O-ring 20x1,5	98197000	£ 3,30	1
a	O-ring 45x2,5	98432000	£ 3,30	1
b	O-ring 47x2,5	98429000	£ 6,10	1
c	O-Ring 14x2,5	98189000	£ 3,30	1