

**AXOR Carlton**  
**Shut-off valve for concealed installation with lever handle**  
Surfaces: Article Number: **17960000**

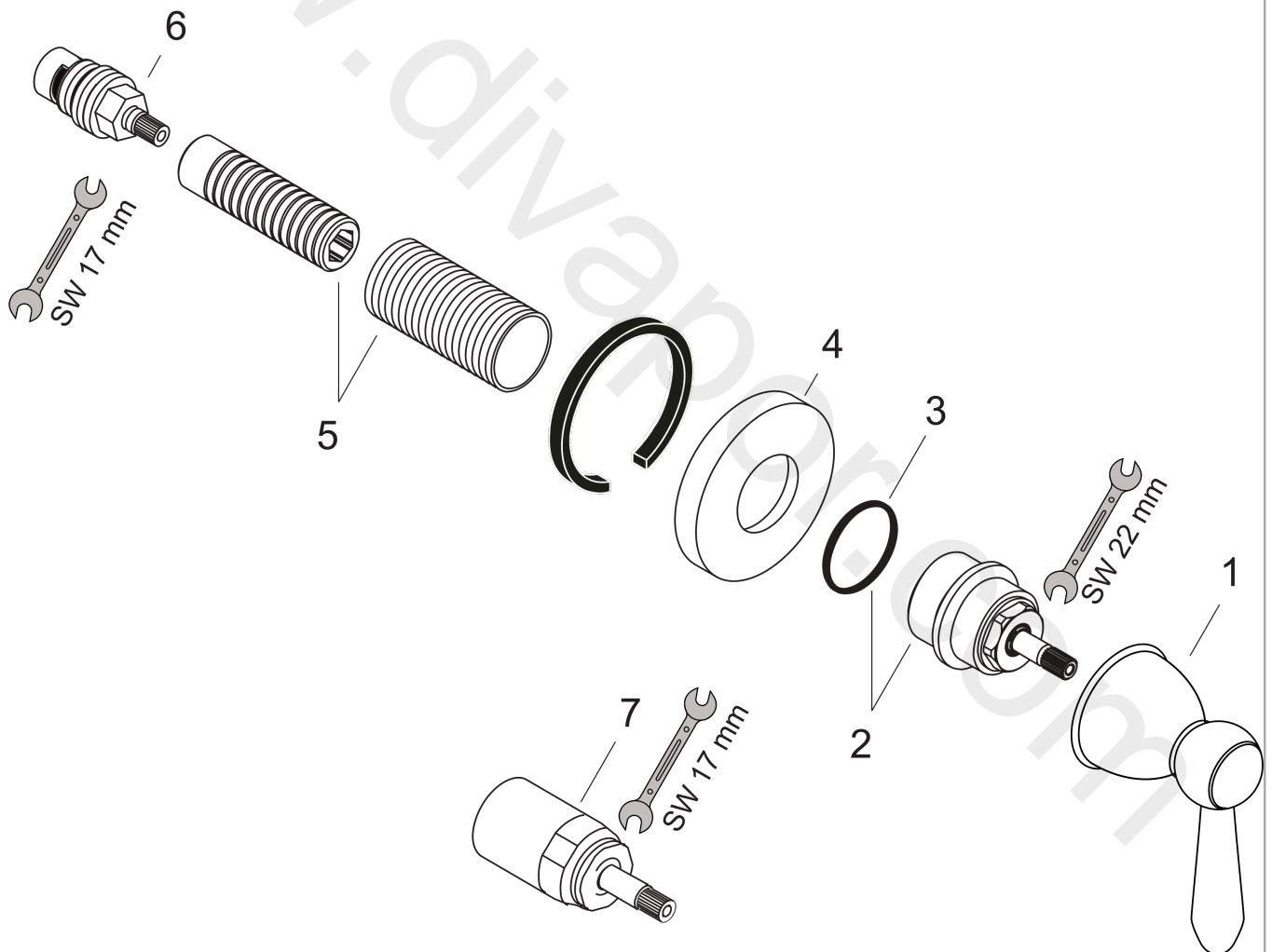

## Exploded Drawing

Year of production: **02/11 - 12/17**



**AXOR Carlton**  
**Shut-off valve for concealed installation with lever handle**  
 Surfaces: Article Number: **17960000**



## Spare part list

Year of production: **02/11 - 12/17**

Pos.		Article Number	Price	PU
1	handle	17294150	£ 275,00	1
2	nut	97358000	£ 43,00	1
3	O-ring 33x1,5	98164000	£ 3,30	1
4	escutcheon Ø 66 mm	94353000	£ 35,00	1
5	fixing set	96392000	£ 35,00	1
6	shut off unit right closing	96350000	£ 51,00	1
7	extension 25 mm	96370000	£ 84,00	1
a	concealed items DN20 (¾")	15970180	£ 138,00	1
b	concealed items ½"	15973180	£ 130,00	1
c	concealed items ½"	15974180	£ 133,00	1