

AXOR Carlton
Thermostatic mixer 59 l/min highflow for concealed installation with lever handle
Surfaces: Article Number: **17712000**

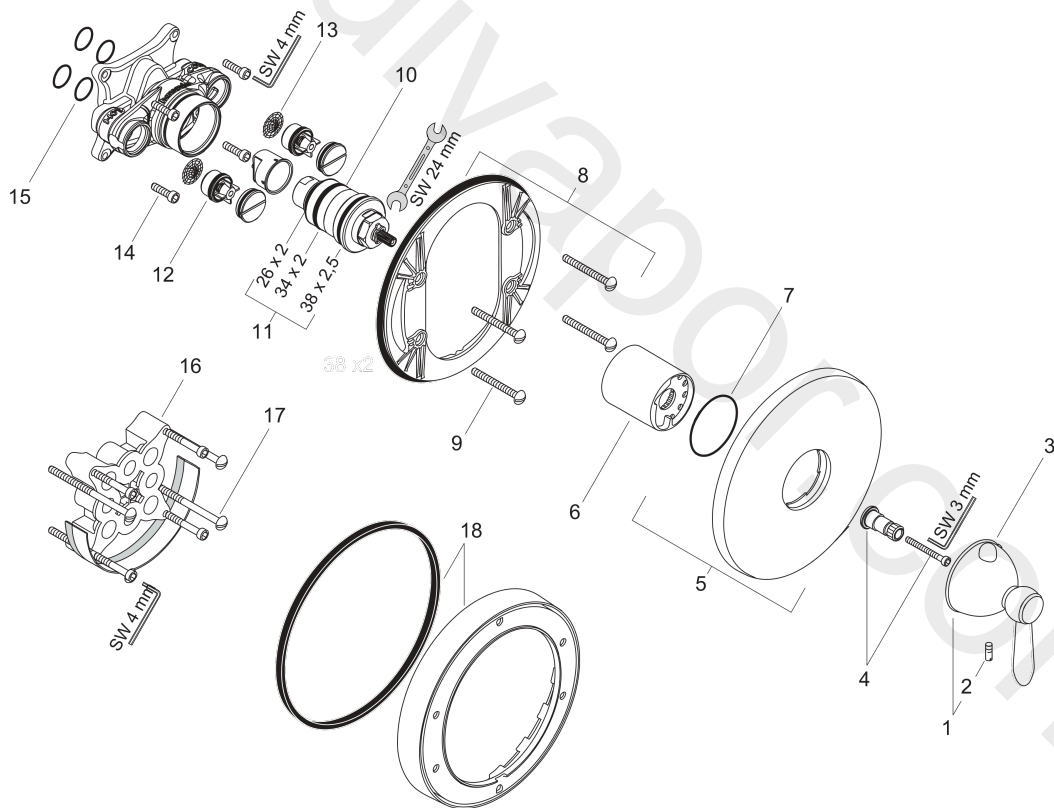

Exploded Drawing

Year of production: **01/05 - 01/12**



AXOR Carlton

Thermostatic mixer 59 l/min highflow for concealed installation with lever handle

Surfaces: Article Number: 17712000



Spare part list

Year of production: 01/05 - 01/12

Pos.		Article Number	Price	PU
1	handle for thermostat	17391000	£ 224,00	1
2	hollow set screw M5x16	97666000	£ 3,30	1
3	pushbutton	97792000	£ 16,10	1
4	adapter for handle	96435000	£ 20,50	1
5	escutcheon Ø 170 mm	96452000	£ 64,00	1
6	sleeve	97439000	£ 43,00	1
7	O-ring 48x5	98174000	£ 3,30	1
8	sub plate	96447000	£ 51,00	1
9	set of fixing screws	96454000	£ 9,00	1
10	thermostat cartridge	96633000	£ 137,00	1
11	sealing set	96636000	£ 51,00	1
12	non return valve	96655000	£ 13,30	1
13	filter	97367000	£ 9,00	1
14	set of screws	96525000	£ 9,00	1
15	O-ring 16x2	98133000	£ 3,30	1
16	extension 25 mm	13595000	£ 75,00	1
17	set of fixing screws	97747000	£ 3,30	1
18	extension 22 mm (Ø 170 mm)	13596000	£ 72,00	1
a	concealed item	01800180	£ 163,00	1
b	pushbutton red	97212000	£ 25,00	1