

AXOR Carlton

Thermostatic mixer for concealed installation with shut-off valve and lever handle

Surfaces: Article Number: 17700000



Exploded Drawing

Year of production: 07/08 - 01/09

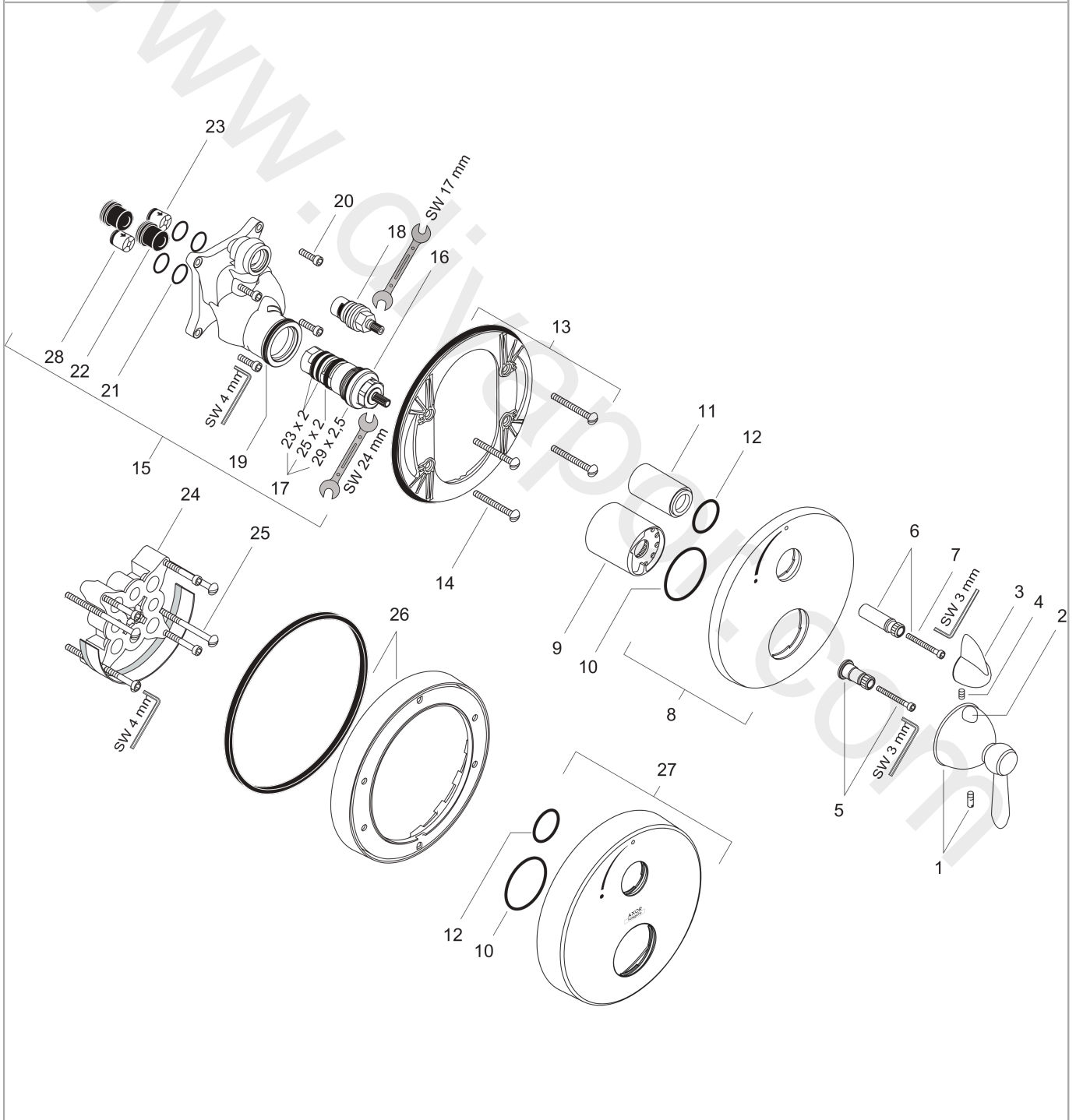

AXOR Carlton

Thermostatic mixer for concealed installation with shut-off valve and lever handle

Surfaces: Article Number: 17700000



Spare part list

Year of production: 07/08 - 01/09

Pos.		Article Number	Price	PU
1	handle for thermostat	17391000	£ 224,00	1
2	pushbutton red	97212000	£ 25,00	1
3	handle	96449000	£ 51,00	1
4	hollow set screw M4x8	97669000	£ 3,30	1
5	adapter for handle	96435000	£ 20,50	1
6	adapter for handle	96451000	£ 16,10	1
7	hexagon socket screw M4x35	92160000	£ 3,30	1
8	escutcheon Ø 170 mm	96551000	£ 64,00	1
9	sleeve	96439000	£ 43,00	1
10	O-ring 48x5	98174000	£ 3,30	1
11	sleeve	96446000	£ 35,00	1
12	O-ring 30x5	98153000	£ 3,30	1
13	sub plate	96447000	£ 51,00	1
14	set of fixing screws	96454000	£ 9,00	1
15	installation unit cpl.	92760000	£ 275,00	1
16	thermostat cartridge	94282000	£ 137,00	1
17	sealing set	95037000	£ 51,00	1
18	shut off unit right closing	94009000	£ 43,00	1
19	O-ring 39x2	98158000	£ 3,30	1
20	set of screws	96525000	£ 9,00	1
21	O-ring 16x2	98133000	£ 3,30	1
22	noise reduction	94073000	£ 25,00	1
23	set of non return valves DW 15	94074000	£ 16,10	1
24	extension 25 mm	13595000	£ 75,00	1
25	set of fixing screws	97747000	£ 3,30	1
26	extension 22 mm (Ø 170 mm)	13596000	£ 72,00	1
27	escutcheon height = 33 mm (when wall is not deep enough).	14963000	£ 71,00	1
28	non return valve (pressure-resistant up to 2 MPa)	92594000	£ 16,10	1
a	pushbutton	97792000	£ 16,10	1
b	concealed item	01800180	£ 163,00	1
c	non return valve with filter	92499000	£ 16,10	1