

AXOR Carlton
Thermostatic bath mixer for exposed installation
Surfaces: Article Number: **17241090**

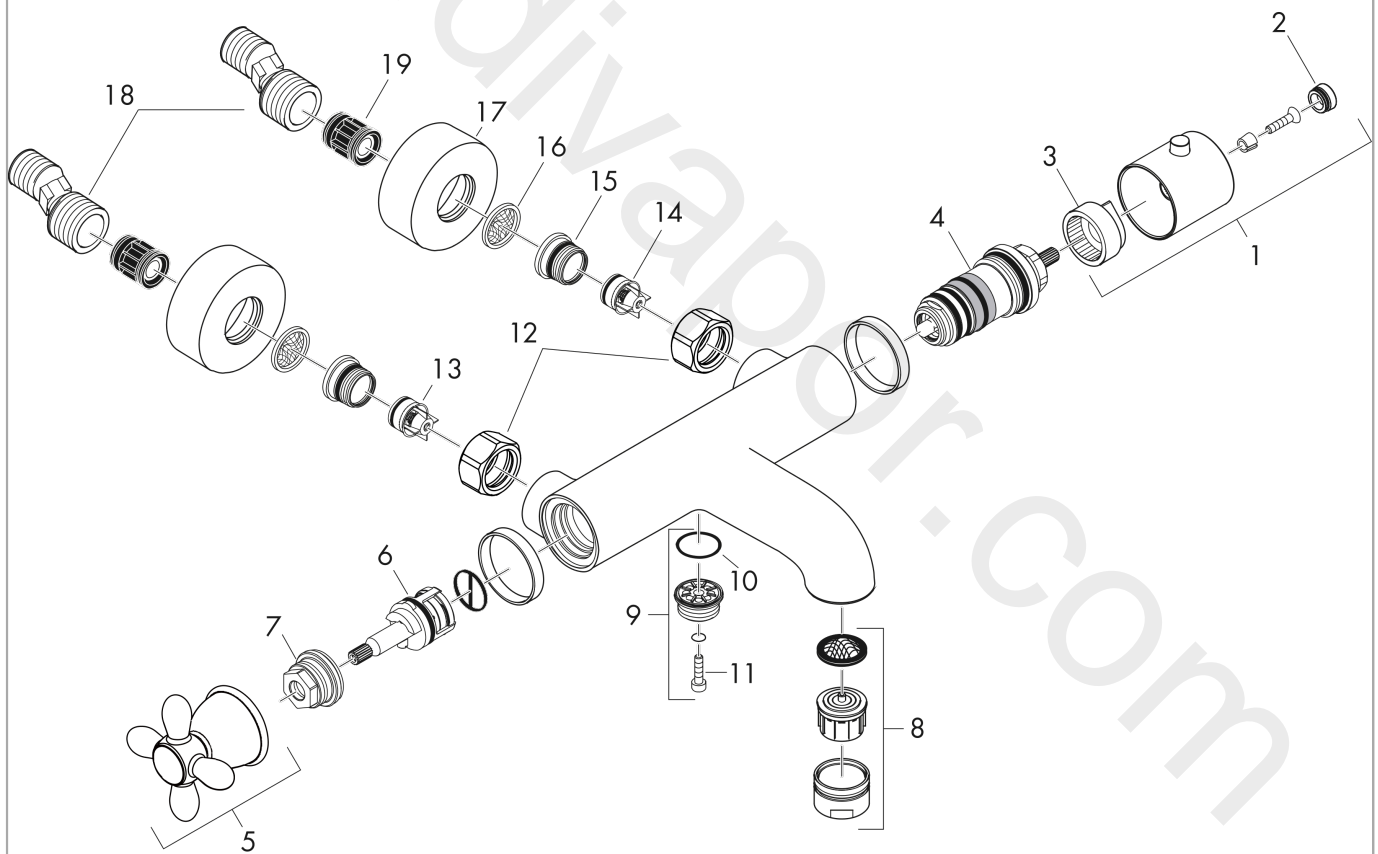

Exploded Drawing

Year of production: **01/06 - 08/19**



AXOR Carlton
Thermostatic bath mixer for exposed installation
 Surfaces: Article Number: **17241090**



Spare part list

Year of production: **01/06 - 08/19**

Pos.		Article Number	Price	PU
1	handle for thermostat	39398000	£ 110,00	1
2	screw cover	98906000	£ 35,00	1
3	safety set for temperature control	95041000	£ 16,10	1
4	thermostat cartridge	94282000	£ 137,00	1
5	handle	17396000	£ 137,00	1
6	nut	92853000	£ 9,00	1
7	shut off unit with selector	96509000	£ 96,00	1
8	aerator M28x1 (25 l/min)	13485000	£ 20,50	1
9	Hose Connection	98556000	£ 35,00	1
10	O-ring 20x1	98140000	£ 3,30	1
11	hexagon socket screw M5x25	97664000	£ 3,30	1
12	set of nuts	96157000	£ 35,00	1
13	non return valve (pressure-resistant up to 2 MPa)	93136000	£ 35,00	1
14	non return valve	96737000	£ 35,00	1
15	O-ring 17x1,5	98137000	£ 3,30	1
16	filter packing	96922000	£ 9,00	1
17	escutcheon Ø 68 mm	96467000	£ 20,50	1
18	set of S-unions (±12 mm)	94140000	£ 51,00	1
19	noise reduction	96429000	£ 6,10	1
a	set of S-unions (±32 mm)	98592000	£ 43,00	1
b	pushbutton	92848000	£ 6,10	1