

AXOR Montreux

Shut-off/ diverter valve Trio/ Quattro for concealed installation with cross handle

Surfaces: Article Number: 16830820



Exploded Drawing

Year of production: 05/06 - 06/17

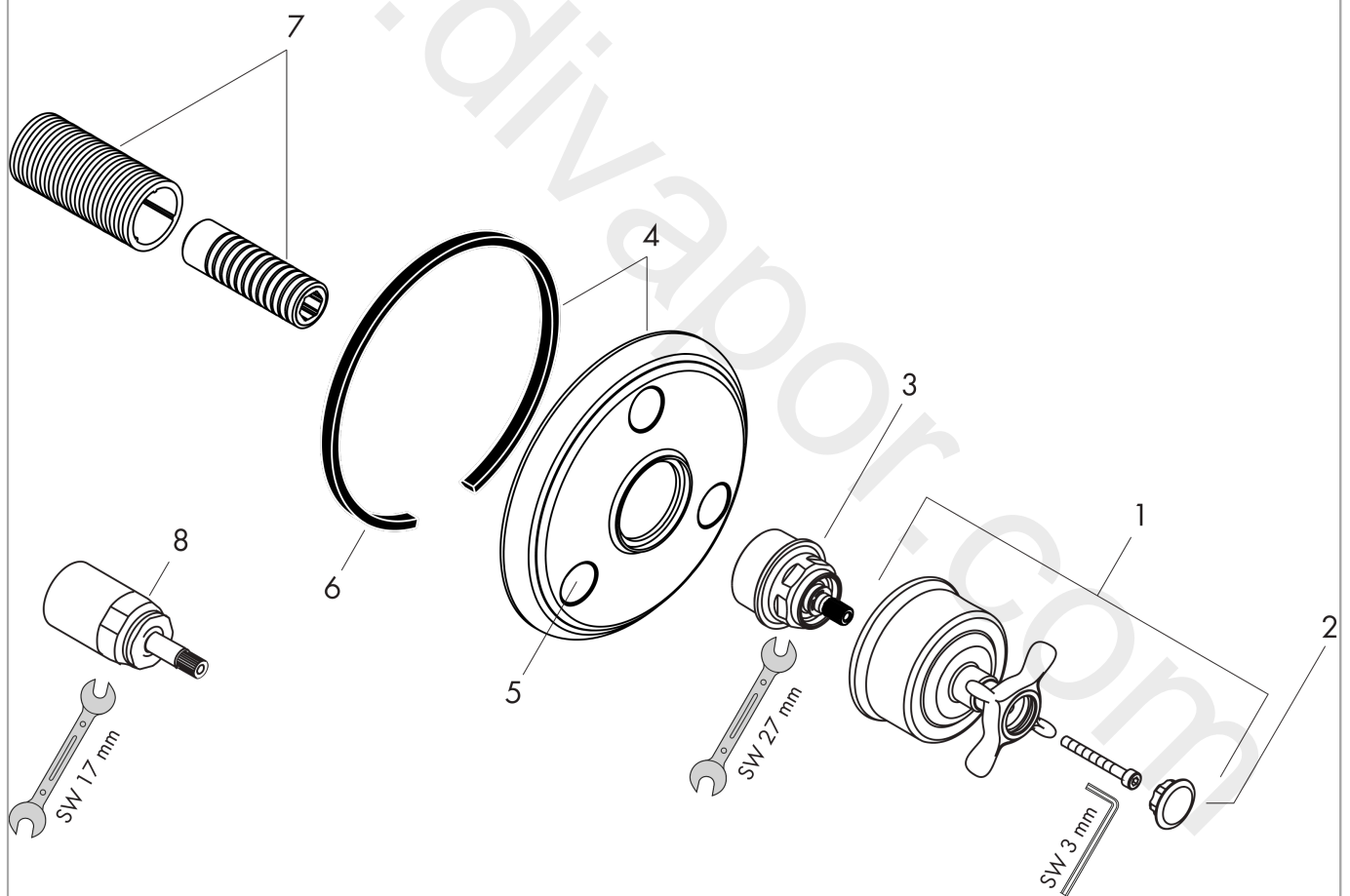

AXOR Montreux
Shut-off/ diverter valve Trio/ Quattro for concealed installation with cross handle
 Surfaces: Article Number: **16830820**



Spare part list

Year of production: **05/06 - 06/17**

Pos.		Article Number	Price	PU
1	handle	16593820	£ 370,00	1
2	set of screw covers, cold / hot water / neutral	97987000	£ 64,00	1
3	nut	98677000	£ 35,00	1
4	escutcheon	98669820	£ 275,00	1
5	stickers for symbols	97218450	£ 20,50	1
6	seal	97737000	£ 9,00	1
7	fixing set	96392000	£ 35,00	1
8	extension 25 mm	96370000	£ 84,00	1
a	concealed item	15981180	£ 250,00	1
b	concealed item	15930180	£ 410,00	1