

**Bath Spout G 3/4,**  
Surfaces: Article Number: 13410000

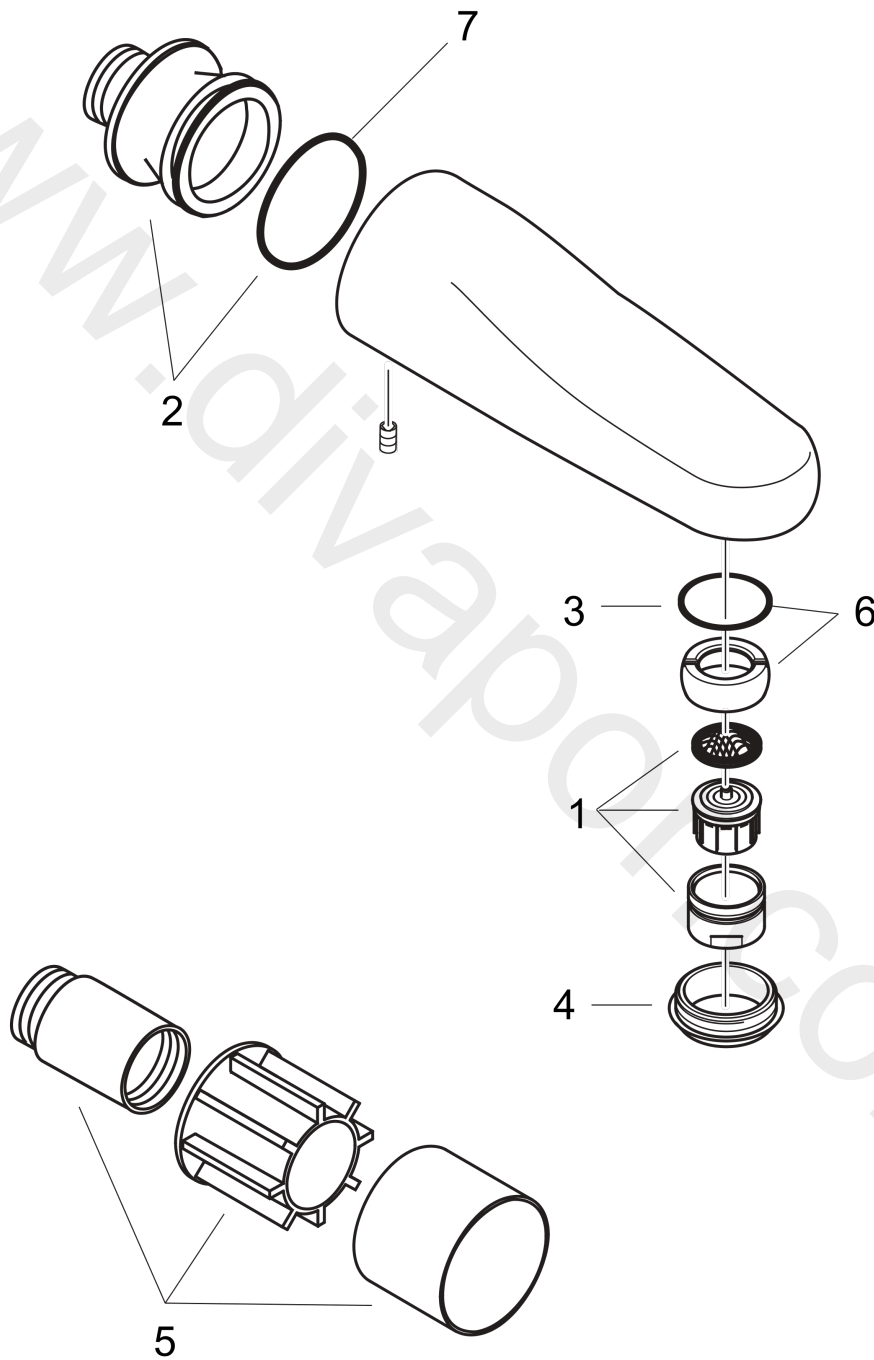

Exploded Drawing

Year of production: 11/81 - 12/08



**Bath Spout G  $\frac{3}{4}$ ,**  
 Surfaces: Article Number: **13410000**



## Spare part list

Year of production: **11/81 - 12/08**

Pos.	Description	Article Number	Price	PU
1	aerator M28x1 (25 l/min)	13485000	£ 20,50	1
2	connecting thread	96455000	£ 43,00	1
3	O-ring 32,5x2,2	94485000	£ 6,10	1
4	nut	96438000	£ 13,30	1
5	extension set 50 mm	13495000	£ 173,00	1
6	ball joint	97526000	£ 16,10	1
7	O-ring 39x3,5	98159000	£ 3,30	1
a	extension 100 mm	13497000	£ 173,00	1