

**AXOR Starck Organic**  
**2-handle basin mixer 170 for wash bowls with waste set**  
 Surfaces: Article Number: **12012830**

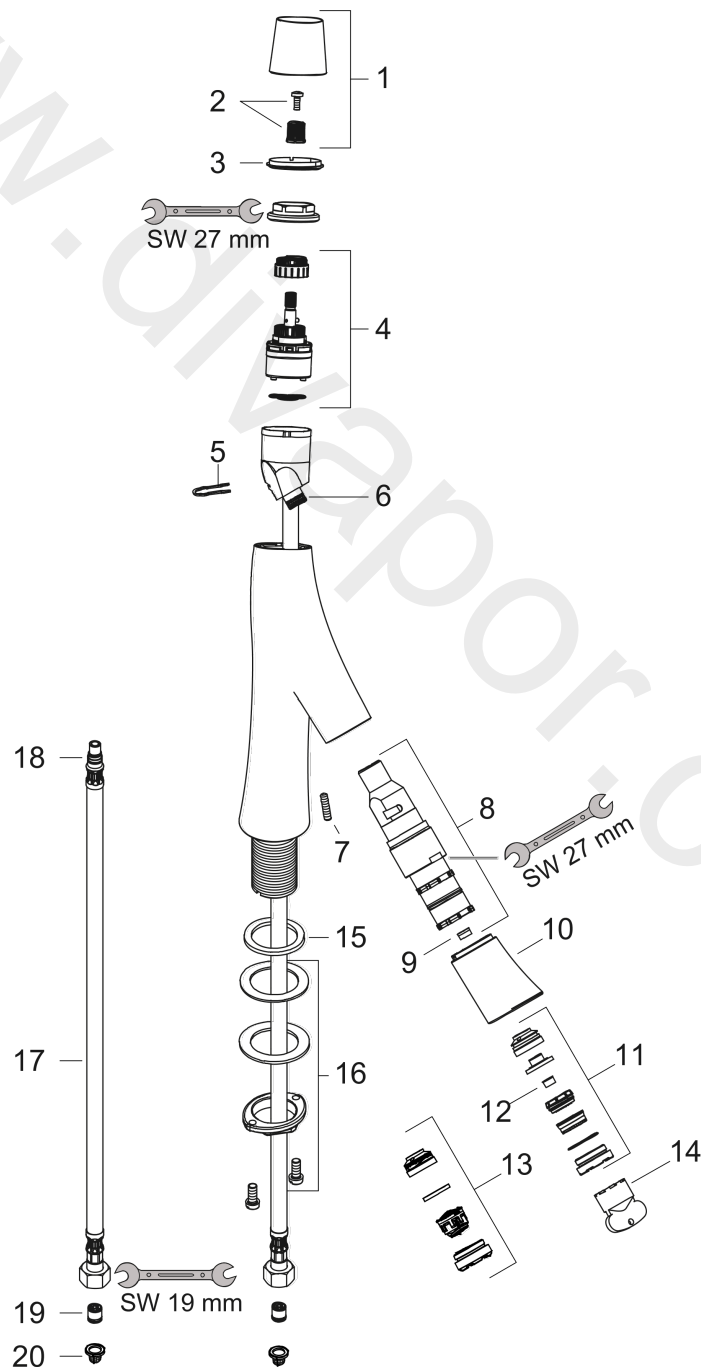

## Exploded Drawing

Year of production: **11/16 - 12/19**



**AXOR Starck Organic**  
**2-handle basin mixer 170 for wash bowls with waste set**  
 Surfaces: Article Number: **12012830**



## Spare part list

Year of production: **11/16 - 12/19**

Pos.		Article Number	Price	PU
1	handle	98296830	£ 118,50	1
2	handle fixing set	98932000	£ 16,10	1
3	color-ring cold / hot water	98304000	£ 9,00	1
4	cartridge, assy	98303000	£ 79,00	1
5	cramp	98403000	£ 9,00	1
6	O-ring 11x1,5	98385000	£ 3,30	1
7	hollow set screw M5x16	98404000	£ 3,30	1
8	shut off cartridge	98301000	£ 173,00	1
9	flow limiter (3,5 l/min)	98405000	£ 9,00	1
10	spout cpl.	98297830	£ 165,00	1
11	spray former	98299830	£ 163,00	1
12	flow limiter (5 l/min)	95311000	£ 6,10	1
13	aerator M24x1 (7 l/min)	98300830	£ 76,50	1
14	special tool	95158000	£ 6,10	1
15	flat seal	98749000	£ 6,10	1
16	fixing set (Ø 32)	13961000	£ 25,00	1
17	connection hose 900 mm M8x0,75 G3/8	95372000	£ 35,00	1
18	O-ring 7x1,5	98422000	£ 3,30	1
19	non return valve DW 10	96456000	£ 9,00	1
20	filter packing	95291000	£ 13,30	1
a	waste	50001830	£ 106,56	1
b	fixation extension 35 mm	13898000	£ 79,00	1